



**TRAFFIC, SIGNALIZATION AND
ROAD SAFETY PRODUCTS CATALOGUE**

www.asyatraffic.com



www.asyatraffic.com

From asya to all over the World



At the Export Summit held in Istanbul in 2016, "**Secret Heroes of Exportation**" award ceremony held on which is organized by Turkish Exporters Assembly (TIM) and Dünya Newspaper. Asya Traffic Signalling Inc. was granted "Young Exporter Jury's special award".



Asya Traffic Inc. was awarded first place out of 3403 companies in **The Successful Entrepreneurs** category by 3rd KOSGEB SME and Entrepreneurs Prizes in 2014



CONTENTS



ASYA TRAFFIC	4
SINTRA	10
SOLTRA	30
LEDTRA	38
PLASTRA	48
REFLECTRA	66

Certificates



Social Media

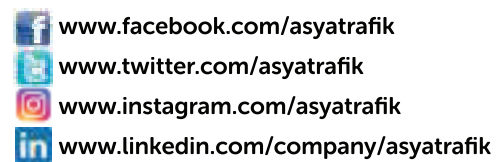



Asya Traffic Inc., was founded to serve in;

- Traffic Systems,
- Signalling Systems,
- Road Safety Products,
- Solar Powered Systems,
- LED Based Systems,
- Traffic Signboards
- Software, Project and Design fields at the year of 2011.

Accordingly, Asya Traffic Inc. which is serving with a capacity which increases every year, is Turkey's the most favorite production, project and application company in it's own sector today.

In our rapidly getting crowded world, when we take into consideration people bustling and moving any moment, all the people approve significance of orderly, securely, speedy traffic. Arriving of people at the place they wanted on time and safely is our fundamental production approach. Therefore every product which was produced at Asya Traffic Inc. plants is ergonomic, long lived and functional. When keeping in view the situation that "Traffic" topic causes a big problem in the world and especially in our country , our primary aim is to offer solutions and to follow, improve , apply the innovations in the world. Definitely, human and environmental factor in all studies we made accordingly are our the foremost topic.

It is our basic production approach that people reach their destinations in time, safely, without stress.



Today our biggest honor is the contribution of our products which provides safety in local, parking areas, places where traffic density to the human life. That's why, we regard every solution we serve up as not "only a job" approach of with the maximization of efficiency and performance, minimization of danger risk. We can say that the biggest property which makes us different at the point we have reached is providing different engineering solutions in the traffic field. We don't regard our job as "only selling product".

Yes we give warranty of providing service and maintenance duty, high quality material, technological innovations they wanted to the people who are interested in traffic or the people who have problems with traffic.

Service Mentality

As being Asya Traffic Inc. unconditioned customer satisfaction is our fundamental principle. Reaching customer efficiently, understanding requests of customers and directing our services into this direction is very important for us at the environment where products' time for entering market, increasing competition in almost all market and decreased margin. Aim of the Asya

Traffic Inc. is serving its customers by knowing that service for our country which developing and progressing is motherland debt, improving itself continuously without making concessions its principles about its work life it protected and developed. Primary criteria of our firm is quality of product not price of product. Our company which works together with the well known suppliers of the world in its field provides reliable and high quality products to its customers. Asya Traffic Inc. who has established customer communication from beginning selection of right product to after sale technical services onto the principle of clearness, taken opinion of "honest enterprise" by its customers up seriously.

Products

SINTRA
Signalling Systems

SOLTRA
Solar Powered Systems

LEDTRA
LED Traffic Signs

PLASTRA
Plastic, Rubber, Metal Road Safety Products

REFLECTRA
Reflective Traffic Signs

CERTIFICATES

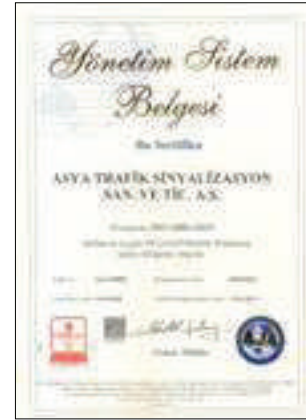

PROJECTS

2020

Ankara – Nigde Intelligent Highway Project – Traffic Signal Heads with LEDs and Flashers (Nigde)

Turkish Highways 13. Reginal Directorate – Signalized Intersection and maintenance of existing signalized intersections for 1 year. (Antalya)

Turkish Highways 9. Regional Directorate – Signalized Intersection and maintenance of existing signalized intersections for 2 years.(Diyarbakir)

2019

Antalya Metropolitan Municipality 3rd Stage Rail System Signalization Project

2018

Ankara Metropolitan Municipality - 70 pcs new signalized intersection and 20 pcs renewing signalized intersection project (Ankara - TURKEY)

Highways Directorate 13. Region - 30 pcs new signalized intersection and 1 year maintenance of existing intersections (Antalya - TURKEY)

2017

Ankara Metropolitan Municipality - 90 pcs new signalized intersection (Ankara - TURKEY)

2016

Yavuz Sultan Selim Bridge Project (İstanbul – TURKEY)

2015

Orhangazi (Samanlı) Tunnel Construction Project (Bursa – TURKEY)

Ashgabat Olympic Village Highway Signalling Project (Ashgabat - TURKMENISTAN)

2013

Kayserey Rail System Project (Kayseri – TURKEY)

2012

HGS – Electronic Toll Collection System Project (İstanbul – TURKEY)

INTERNATIONAL EXHIBITIONS

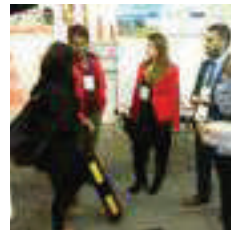
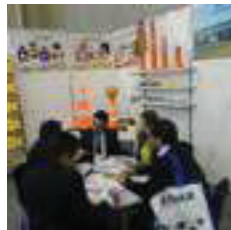

APPLICATION PHOTOS



SINTRA
TAG Pole
ANTALYA

PLASTRA
Delineator
CROATIA

PLASTRA
Rubber Speed Bump
İSTANBUL



LEDTRA
Variable Message Sign (VMS)
DIYARBAKIR

LEDTRA
Variable Message Sign (VMS)
BURSA

LEDTRA
VTS
KONYA

LEDTRA
VTS
MALATYA

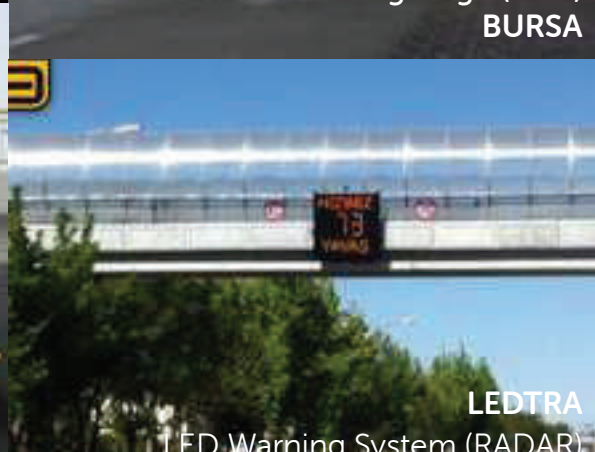

PLASTRA
Marmaris Bicycle Road
MUĞLA

LEDTRA
LED Warning System (RADAR)
NIĞDE

LEDTRA
Variable Message Sign (VMS)
VAN



PLASTRA
Variable Message Sign (VMS)
ANKARA

PLASTRA
TPU Delineator
ESTONYA



REFLECTRA
Car Park Project
ISTANBUL



REFLECTRA
Car Park Project
ISTANBUL



REFLECTRA
Car Park Project
ISTANBUL



SINTRA
Intersection Signalisation
ANKARA



SINTRA
HGS Electronic Toll
Collection Project
ISTANBUL



SINTRA
Traffic Training Park
KEPEZ



SINTRA
Intersection Signalisation
ANTALYA

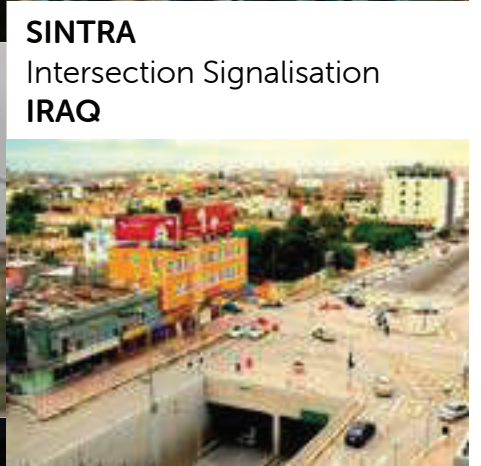

SINTRA
Intersection Signalisation
IRAQ



PLASTRA
TPU
DUBAI



SOLTRA
Solar LED Triangle Flasher
IRAQ

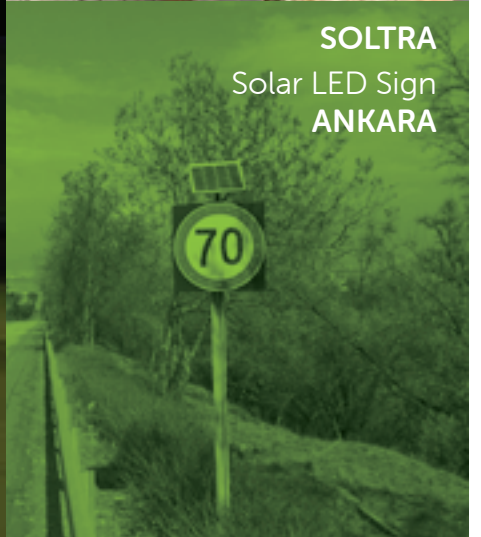

SOLTRA
Solar LED Sign
ANKARA



SOLTRA
Solar Flasher
ARTVIN

SIGNALLING SYSTEMS

Sintra products are manufactured according to the traffic and road safety standards.

Sintra products are used in 81 cities in Turkey and used in more than 50 countries around the world.

Power LED Signal Heads: TS EN 12368 certificated Power LED modules with IP 65 protection level. All housing materials are made of %100 UV PC.

Controllers: TS EN 50556 certificated, modular structure, green wave system adaptable, central software supported, programmable via computer, microprocessor based CPU.

Audible Pedestrian Signal: Audible signal for blinds, RILSA standards, warning signal voice level is arranged automatically according to the environment.

Infrastructure Equipments: Galvanized Signalling Poles with Highways and Municipality standards, corrosion resistant.





SINTRA POWER LED SIGNAL HEADS

Diameter	200 mm /300 mm
Housing / Mask Material Type	Polycarbonate (%100 PC)
Housing Color	Black / Grey-Black
LED	Power LED / Red, Yellow, Green
Light Distribution	Fresnel Lens
Power Factor	PF>0.9, THD<%20
Phantom Class	5
Power Consumption	8 Watt / Module
Certificate	TS EN 12368:2015

Product Types and Codes

SN-04-02-200	200 mm Vehicle Signal with Sintra Power LEDs (Black / Sintra Housing)
SN-01-02-200	200 mm Vehicle Signal with Sintra Power LEDs (Black / Standard Housing)
SN-04-02-300	300 mm Vehicle Signal with Sintra Power LEDs (Black / Sintra Housing)
SN-01-02-300	300 mm Vehicle Signal with Sintra Power LEDs (Black / Standard Housing)
SN-04-02-275	200 mm Single Signal with Sintra Power LEDs (Black / Sintra Housing)
SN-01-02-275	200 mm Single Signal with Sintra Power LEDs (Black / Standard Housing)
SN-04-02-350	300 mm Single Signal with Sintra Power LEDs (Black / Sintra Housing)
SN-01-02-350	300 mm Single Signal with Sintra Power LEDs (Black / Standard Housing)
SN-04-02-201	200 mm Vehicle Signal with Arrow (Black / Sintra Housing)
SN-01-02-201	200 mm Vehicle Signal with Arrow (Black / Standard Housing)
SN-04-02-301	300 mm Vehicle Signal with Arrow Sintra Power LEDs (Black / Sintra Housing)
SN-01-02-301	300 mm Vehicle Signal with Arrow Figure / Sintra Power LEDs (Black / Standard Housing)
SN-04-02-250	200 mm Pedestrian Signal with Sintra Power LEDs (Black / Sintra Housing)
SN-01-02-250	200 mm Pedestrian Signal with Sintra Power LEDs (Black / Standard Housing)



200 mm SINTRA POWER LED TRAFFIC SIGNAL MODULE

SY-01-041

Diameter	200 mm
Front Shell	Tinted, Clear
Color	Red, Yellow, Green
Light Intensity	400 - 800 cd
Light Source	Power LED
Power Consumption	8W
Operating Voltage	220-240 V AC 50/60 Hz
Phantom Class	5
Power Factor	>%90
Total Harmonic Distortion (THD)	<%20
IP Class	IP 65
Weight	0,7 kg
Certificates	TS EN 12368:2015
Operating Temperature	-40°/+60°C

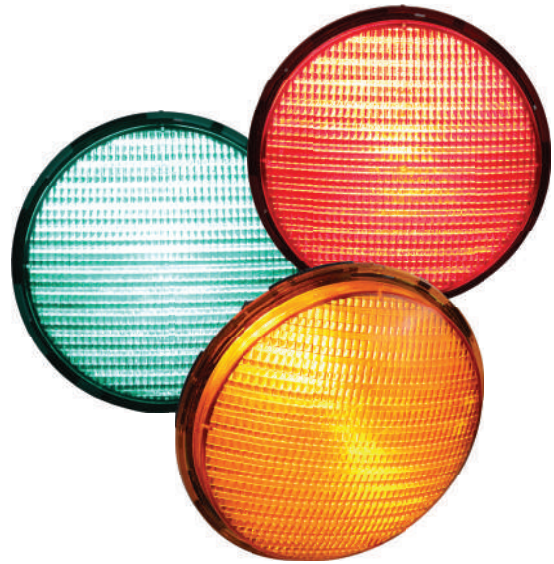

300 mm SINTRA POWER LED TRAFFIC SIGNAL MODULE

SY-01-046

Diameter	300 mm
Front Shell	Tinted, Clear
Color	Red, Yellow, Green
Light Intensity	400 - 800 cd
Light Source	Power LED
Power Consumption	8W
Operating Voltage	220-240 V AC 50/60 Hz
Phantom Class	5
Power Factor	>%90
Total Harmonic Distortion (THD)	<%20
IP Class	IP 65
Weight	1,1 kg
Certificates	TS EN 12368:2015
Operating Temperature	-40°/+60°C

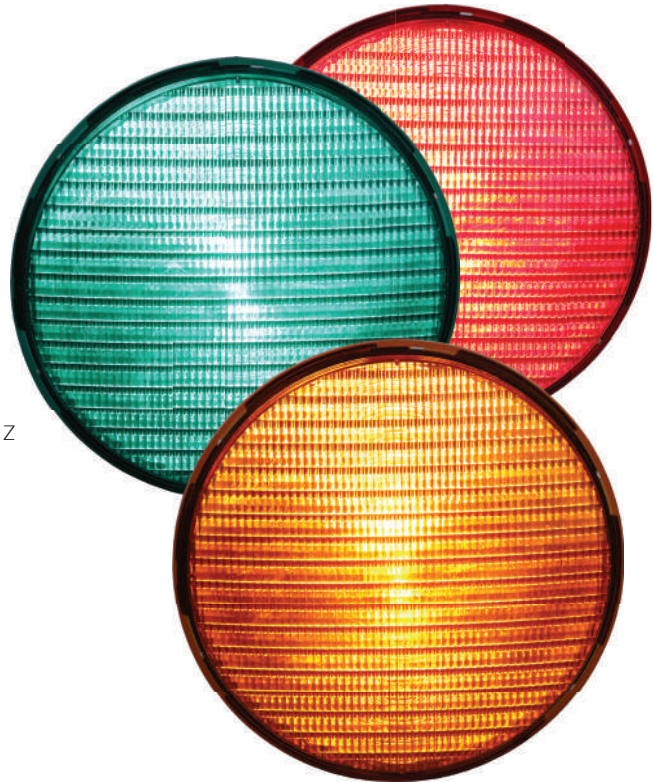

DIMMABLE SINTRA POWER LED SIGNAL HEADS



Product Types and Codes

SN-04-02-200GD	200 mm Vehicle Dimmable Sintra Power LED Gray Glass
SN-04-02-250GD	250 mm Vehicle Dimmable Sintra Power LED Gray Glass
SN-04-02-300GD	300 mm Vehicle Dimmable Sintra Power LED Gray Glass

Diameter (LED module)	300 mm
Housing / Mask Material Type	Polycarbonate (% 100 PC)
Housing Color	Black
LED (Type / Color)	Power LED / Red, Yellow, Green
Lens Type	Gray
Light Distribution	Fresnel Lens
Power Factor	PF>0.9, THD<20%
Phantom Class	5
Dim Class	D1 (Dimmable)
Power Consumption	Max 8 Watts / Module
Certificates	TS EN 12368:2015, IP 65

ASYA POWER LED SIGNAL HEADS

Diameter	200 mm /300 mm
Housing /Mask Material Type	Polycarbonate (% 100 PC)
Housing Color	Black / Grey-Black
LED	Power LED / Red, Yellow, Green
Phantom Class	3
Power Consumption	7 Watt / Module
Certificate	TS EN 12368: 2015

Product Types and Codes

- SN-01-01-200** 200 mm Vehicle Signal with Power LEDs (Black / Standard Housing)
- SN-04-01-200** 200 mm Vehicle Signal with Power LEDs (Black / Sintra Housing)
- SN-01-01-250** 200 mm Pedestrian Signal with Power LEDs (Black / Standard Housing)
- SN-04-01-250** 200 mm Pedestrian Signal with Power LEDs (Black / Sintra Housing)
- SN-01-01-275** 200 mm Single Signal with Power LEDs (Black / Standard Housing)
- SN-04-01-275** 200 mm Single Signal with Power LEDs (Black / Sintra Housing)
- SN-01-01-300** 300 mm Vehicle Signal with Power LEDs (Black / Standard Housing)
- SN-04-01-300** 300 mm Vehicle Signal with Power LEDs (Black / Sintra Housing)
- SN-01-01-350** 300mm Single Signal with Power LEDs (Black / Standard Housing)
- SN-04-01-350** 300 mm Single Signal with Power LEDs (Black / Sintra Housing)
- SN-01-01-290** 200 mm Vehicle Signal with Arrow Figure (Black / Standard Housing)
- SN-04-01-201** 200 mm Vehicle Signal with Arrow Figure (Black / Sintra Housing)
- SN-01-01-380** 300 mm Vehicle Signal with Arrow Figure (Black / Standard Housing)
- SN-04-01-301** 300 mm Vehicle Signal with Arrow Figure (Black / Sintra Housing)
- SN-01-01-251** 200 mm Double Signal with Power LEDs Red\Green (Black / Standard Housing)
- SN-04-01-255** 200 mm Double Signal Head with Power LEDs Red\Green (Black / Standard Housing)



100mm POWER LED SIGNAL HEADS

Diameter	100 mm
Housing /Mask Material Type	Polycarbonate (% 100 PC)
Housing Color	Black / Grey-Black
LED	Power LED / Red, Yellow, Green
Power Consumption	5 Watt / Module

Product Types and Codes

- SN-04-01-100** 100 mm Vehicle Signal with Power LEDs (Black / Sintra Housing)
- SN-04-01-101** 100 mm Power LED Signal with Triple Bicycle (Black / Sintra Housing)
- SN-04-01-150** 100 mm Pedestrian Signal with Power LEDs (Black-Sintra Housing)
- SN-04-01-152** 100 mm Power LED Signal with Double Bicycle (Black / Sintra Housing)
- SN-04-01-122** 100 mm Single Signal with Yellow Power LEDs (Black / Sintra Housing)
- SN-04-01-151** 100 mm Double Signal with Power LEDs (Black-Sintra Housing)

100mm LED SIGNAL HEADS

Diameter	100 mm
Housing /Mask Material Type	Polycarbonate (% 100 PC)
Housing Color	Black / Grey-Black
LED	5 mm LED
Power Consumption	2 Watt / Module

Product Types and Codes

- SN-04-40-100** 100 mm Vehicle Signal with LEDs (Black-Sintra Housing)
- SN-04-40-150** 100 mm Pedestrian Signal with LEDs (Black-Sintra Housing)
- SN-04-40-155** 100 mm Double Signal with LEDs (Black-Sintra Housing)
- SN-04-40-180** 100 mm Single Signal with LEDs (Black-Sintra Housing)



5mm LEDs SIGNAL HEADS

Diameter	200 mm / 300 mm
Housing /Mask Material Type	Polycarbonate (% 100 PC)
Housing Color	Black / Grey-Black
LED	5 mm Transparent / Red, Yellow, Green
Power Consumption	12 Watt - 18 Watt / Module
Certificate (IP Class)	TS EN 12368:2015

Product Types and Codes

- SN-01-40-200** 200 mm Vehicle Signal with 5 mm LEDs (Black / Standard Housing)
- SN-04-40-200** 200 mm Vehicle Signal with 5 mm LEDs (Black / Sintra Housing)
- SN-01-40-250** 200 mm Pedestrian Signal with 5 mm LEDs (Black / Standard Housing)
- SN-04-40-250** 200 mm Pedestrian Signal with 5 mm LEDs (Black / Sintra Housing)
- SN-01-40-275** 200 mm Single Signal with 5 mm LEDs (Black / Standard Housing)
- SN-04-40-275** 200 mm Single Signal with 5 mm LEDs (Black / Sintra Housing)
- SN-01-40-300** 300 mm Vehicle Signal with 5 mm LEDs (Black / Standard Housing)
- SN-04-40-300** 300 mm Vehicle Signal with 5 mm LEDs (Black / Sintra Housing)
- SN-01-40-350** 300 mm Single Signal with 5 mm LEDs (Black / Standard Housing)
- SN-04-40-350** 300 mm Single Signal with 5 mm LEDs (Black / Sintra Housing)
- SN-01-40-290** 200 mm Vehicle Signal with Arrow 5 mm LEDs (Black / Standard Housing)
- SN-04-40-201** 200 mm Vehicle Signal with Arrow 5 mm LEDs (Black / Sintra Housing)
- SN-01-40-380** 300 mm Vehicle Signal with Arrow 5 mm LEDs (Black / Standard Housing)
- SN-04-40-301** 300 mm Vehicle Signal with Arrow 5 mm LEDs (Black / Sintra Housing)





300 mm GRAPHIC COUNTDOWN VEHICLE SIGNAL (BLACK / STANDARD)

SN-01-06-301

Diameter (LED Module)	300 mm
Housing Color / Type	Black / Standard
Housing / Mask Material Type	Polycarbonate (% 100 PC)
LED (Type / Color)	5 mm LED / Red, Yellow, Green
Certificate	(TS EN 12368)
Power Consumption	15W / Module
Input Voltage	220 V AC 50 Hz
LED Signal Type	Full Graphic
LED Module Protection	IP 65



300 mm VEHICLE SIGNAL WITH RED AND GREEN COUNTDOWN (BLACK / STANDARD)

SN-01-06-300

Diameter (LED Module)	300 mm
Housing Color / Type	Black / Standard
Housing / Mask Material Type	Polycarbonate (% 100 PC)
LED (Type / Color)	5 mm LED / Red, Yellow, Green
Power Consumption	15W / Module
Input Voltage	220 V AC 50 Hz
LED Module Protection	IP 65



300 mm VEHICLE SIGNAL WITH YELLOW COUNTDOWN MODULE (BLACK / STANDARD)

SN-01-60-300

Diameter (LED Module)	300 mm
Housing Color / Type	Black / Standard
Housing / Mask Material Type	Polycarbonate (% 100 PC)
LED (Type / Color)	5 mm LED / Red, Yellow, Green
Certificate	(TS EN 12368)
Power Consumption	15W / Module
Input Voltage	220 V AC 50 Hz
LED Module Protection	IP 65

ANIMATED PEDESTRIAN SIGNAL WITH COUNT DOWN (GREEN ALUMINIUM BODY) SN-05-40-300

Size	370 x 670 x 70 mm
Weight	9kg
Housing Color	Green
Housing Material Type	Aluminum
LED	5mm Red, Green
Power Consumption	Max 30 Watt
Product Type	Graphics Count Down Animated Pedestrian Set



300 mm STAINLESS HOUSING LED VEHICLE SIGNAL SN-05-40-300

Diameter	300 mm
Housing Material Type	Mirrored Stainless Housing
Housing Color	Silver
LED	5 mm Transparent Red , Yellow , Green
Power Consumption	Max 18 Watt
Weight	21 kg
Size	112 cm x 37 cm x 45 cm



LED TRAFFIC COUNTDOWN TIMER

Diameter	200 mm / 300 mm
Housing /Mask Material Type	Polycarbonate (% 100 PC)
Housing Color	Black / Grey-Black
LED	5 mm Transparent / Red, Yellow, Green
Power Consumption	10 Watt - 15 Watt / Module
Certificate (IP Class)	TS EN 12368:2015



Product Types and Codes

- SN-01-05-200 200 mm Traffic Countdown Timer with LEDs (Black / Standard Housing)
- SN-04-05-200 200 mm Traffic Countdown Timer with LEDs (Black / Standard Housing)
- SN-01-05-250 200 mm Animated Pedestrian Signal with LEDs (Black / Standard Housing)
- SN-04-05-250 200 mm Animated Pedestrian Signal with LEDs (Black / Sintra Housing)
- SN-01-05-300 300 mm Traffic Countdown Timer with LEDs (Black / Standard Housing)
- SN-04-05-300 300 mm Traffic Countdown Timer with LEDs (Black / Sintra Housing)
- SN-01-05-320 300 mm Countdown Timer with 2.5 Digits LEDs (Black / Standard Housing)
- SN-04-05-320 300 mm Countdown Timer with 2.5 Digits LEDs (Black / Sintra Housing)
- SN-01-05-325 300 mm Graphic Countdown Timer with LEDs (Black / Standard Housing)
- SN-04-05-325 300 mm Graphic Countdown Timer with LEDs (Black / Sintra Housing)
- SN-01-05-350 300 mm Animated Pedestrian Signal with LEDs (Black / Standard Housing)
- SN-04-05-350 300 mm Animated Pedestrian Signal with LEDs (Black / Sintra Housing)
- SN-01-40-260 200 mm Static Pedestrian Signal with LEDs (Black / Standard Housing)
- SN-04-40-260 200 mm Static Pedestrian Signal with LEDs (Black / Sintra Housing)
- SN-01-05-400 300 mm Adaptive Countdown Timer For Dynamic Intersections (Black / Standard Housing)
- SN-04-05-400 300 mm Adaptive Countdown Timer For Dynamic Intersections (Black / Sintra Housing)



200 mm STOP / WALK SIGNAL WITH LEDS (BLACK / STANDARD)

SN-01-45-200

Diameter	200 mm
Housing Material Type	Polycarbonate (% 100 PC)
Housing Color	Black / Grey Black
LED (Type / Color)	9 mm / Red, Green
Power Consumption	7 W / Module
Certificates	IP 65
Operating Voltage	12 V DC / 24 V DC / 220 V AC



200 mm ANIMATED PEDESTRIAN SIGNAL WITH COUNTDOWN TIMER WITH LEDS

SN-01-05-275

Diameter	200 mm
Weight	6 kg
Housing / Mask Material Type	Polycarbonate (%100 PC)
Housing Color	Black / Grey-Black
Input Voltage	220 V AC 50 Hz
LED	5mm, Red, Green
Power Consumption	30 Watt



300 mm ANIMATED PEDESTRIAN SIGNAL WITH COUNTDOWN TIMER WITH LEDS

SN-01-05-375

Diameter	300 mm
Weight	9 kg
Housing / Mask Material Type	Polycarbonate (%100 PC)
Housing Color	Black / Grey-Black
Input Voltage	220 V AC 50 Hz
LED	5mm, Red, Green
Power Consumption	30 Watt



80 x 60 cm COUNTDOWN TIMER WITH LEDES

SN-01-05-500

	800 x 600 mm
Ağırlık	24 kg
Gövde/Malzeme	Metal
Gövde Renk	Siyah
	5 mm Kırmızı, Sarı, Yeşil
Güç Tüketimi	30 Watt

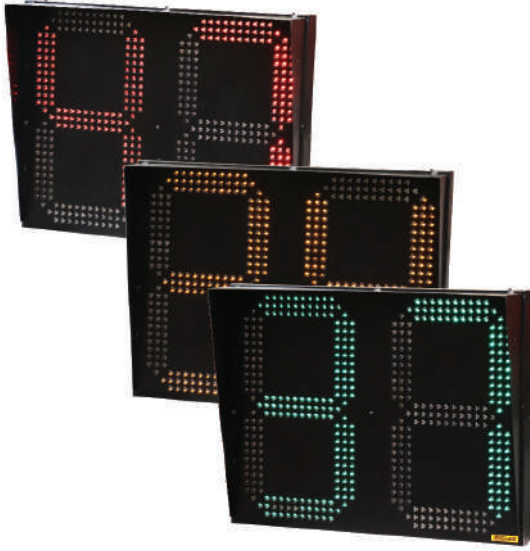

40 x 60 cm COUNTDOWN TIMER WITH LEDES

SN-01-05-502

Size	400 x 600 mm
Weight	15 kg
Housing Type	Metal
Housing Color	Black
LED	3 colors, 5mm, Red, Yellow, Green
Power Consumption	17 Watt



52.9 x 47 cm COUNTDOWN TIMER WITH LEDES

SN-01-05-501

Size	520 x 470 mm
Weight	8 kg
Housing Type	Aluminium
Housing Color	Black
Input Voltage	220 V AC 50 Hz
LED	2 colors, 5mm, Red, Green
Power Consumption	5 Watt



ACCESSIBLE PEDESTRIAN TOUCH BUTTON

SN-07-008

Dimensions	120 x 270 x 84 mm
Weight	2 kg
Body Type	Polycarbonate
Body Color	Yellow-Black
Operating Voltage	220 V AC
Voice Level	Automatic / Acoustic Characteristic (According to the Environment dB Level)
Detection	Touch Sensor
Front Face	Illuminated (Desired Logo and Figure can be made)
Mounting	With rubber backboard, suitable with Standard and Overhead Signal Pole
IP Class	IP 65
Product Type and Codes	SN-07-010 Contactless T.B.



ACOUSTIC AUDIBLE PEDESTRIAN TOUCH BUTTON

SN-07-006

Dimension	24 x 97 x 106 mm
Weight	950 g
Body Type	Polycarbonate
Body Color	Yellow - Black
Operating Voltage	220 V AC
Voice Level	Automatic / Acoustic Characteristic (According to the Environment dB Level)
Detection	Touch Sensor

ACOUSTICAL SIGNAL TRANSMITTER FOR PEDESTRIANS

SN-07-005

Dimension	28 x 18 x 13,5 cm
Weight	1,9 kg
Body	%100 PC, Black
Operating Voltage	220 V
Intended Use	Audible warning for visually impaired
Voice Level	Automatic, according to the environment dB level
Voice dB	30-90 dB
Voice tone	Warning messages or "Beep" tone



200 mm - 300 mm TOTEM TRAFFIC LIGHT

SN-09-01-200

SN-09-01-300



Input Voltage
Material Type

220 V AC 50 Hz
Electrostatic Powder Coated
Metal Structure
Grey / Black

Housing Color
Housing Size
300mm
200mm

426 x 187 x 4000 mm
350 x 187 x 3500 mm





Bottom View

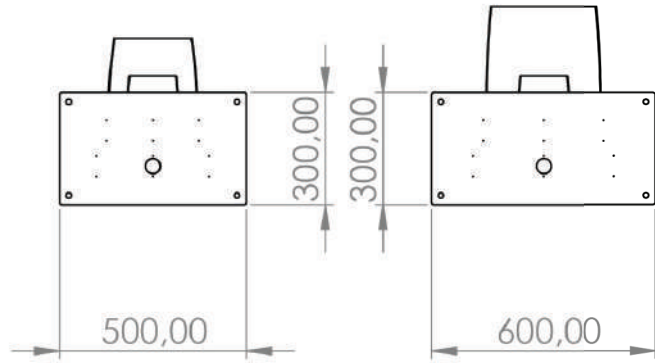
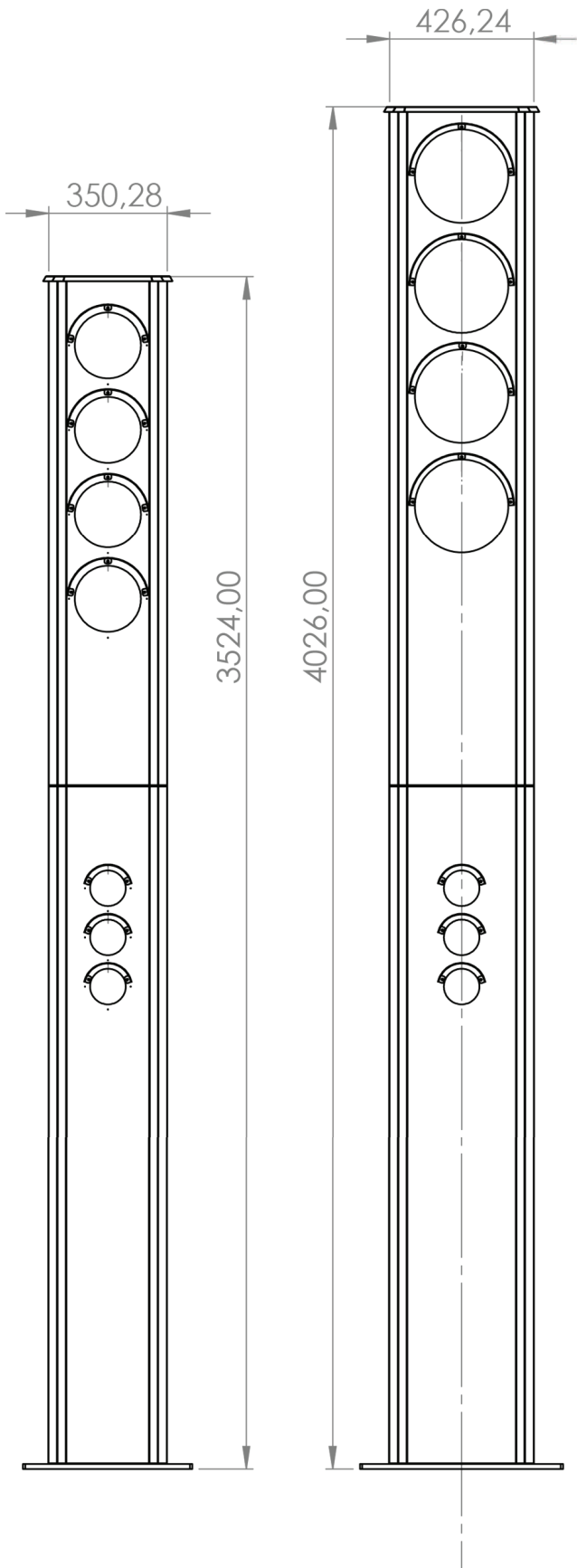



OVERHEAD / L POLE

Protection	Galvanised
Pipe Type	114 x 4 mm, 139 x 5 mm, 89 x 4 mm cylindrical iron pipe
Standard	TS 301/2, Turkish Directorate of Highways Standards
Height	6 mt
Product Type and Codes	SN-05-600 Without Anchorage Base SN-05-625 With Anchorage Base



STANDARD POLE

Protection	Galvanised
Pipe Type	114x4 mm cylindrical iron pipe
Standard	TS 301/2, Turkish Directorate of Highways Standards
Height	4 m
Product Type and Codes	SN-05-001 Without Anchorage Base SN-05-612 With Anchorage Base



TAG SIGNAL POLE (N/U - TYPE)

Height	6m
Wide	Depending on road width, between 10 mt. and 15 mt.
Coating	Hot-dip galvanized
Pole Type	159 x 5 mm Cylindrical iron pipe



INTERSECTION CONTROLLER STAND SN-10-001

Size	90 x 79 cm
Weight	17 kg
Paint	Electrostatic Paint
Intended Use	Used at installation of controller



INTERSECTION CONTROLLER POLE SN-01-005

Size	150 cm
Weight	24 kg
Paint	Hot dip galvanized coating
Intended Use	Used at installation of controller



GROUND ROD SN-10-010

Material Type	Copper
Size	1 m
Weight	1.5 kg



COMPOSITE MANHOLE COVER (COMPOSITE JOINT BOX)

SN-10-023

Dimensions	485 x 485 x 400 mm
Material Type	Fiber Reinforced Plastics
Weight	20 kg
Body Thickness	10 mm
Bending Strength (Mpa)	Min. 150
Barcol Hardness (Kj/m²)	Min 35
Water Absorption (%)	Max. 70 mg.
Density (Gr/Cm³)	Min. 1.5
Incombustibility Class	Bff S 1

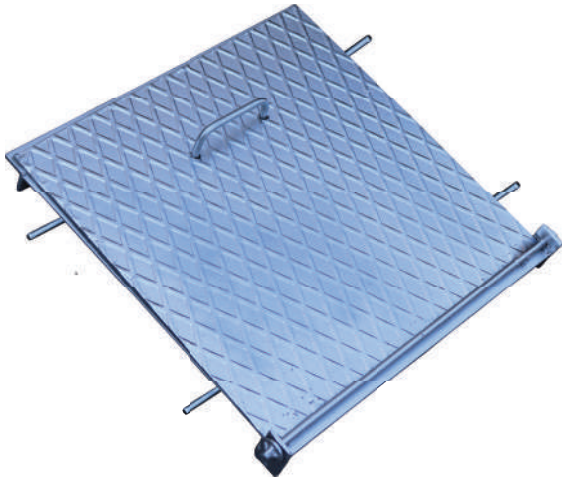

MANHOLE COVER

SN-10-015

Material	Galvanised
Metal Size	40 x 40 cm
Weight	7.5 kg



PEDESTRIAN BUTTON

SN-07-001

Compatible Pole	Standard / Overhead Pole
Compatible Device	All devices which have pedestrian button output.
Intended Use	Used when pedestrians want to pass across the road.



GREEN WAVE SATELLITE MODULE (GPS)

SN-15-010

Synchronization
Compatible Device
Master Intended Use

GPS
Maestro, Master
Green Wave System



FLASHER DEVICE

SN-10-015

Operating Voltage
Product Type
Intended Use

220 V
In the LED module or on the pole
Switch to flash position



CROSSING PAVEMENT LIGHT (FOR PEDESTRIAN)

SN-15-050

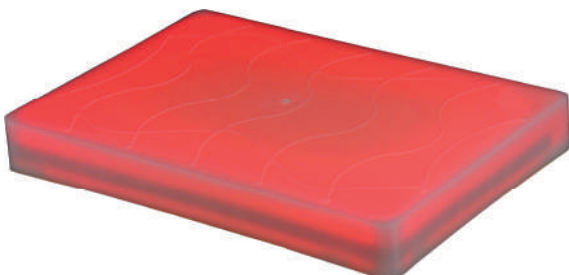

Size
Weight
Operating Voltage
Material (Body)
LED
Protection
Mounting

300 x 200 x 35 mm
2.4 kg
24 V DC
Polycarbonate
Red and Green LED Strip
Resin-casting
Holes are opened on the pavement and placed i
it and glued with its adhesive



4 AND 8 GROUP POLE TYPE PEDESTRIAN CONTROLLER

SN-15-040
SN-15-041

Dimensions 400 x 400 x 200 mm
Weight 9 kg
Technical Specifications 8 groups, (Periods can be adjusted by computer program)
Montaj With 2 pole clamps



PROGRAMMABLE SIGNAL CONTROL UNIT

SN-15-042

Size 200 x 300 x 130 mm
Weight 1.50 kg
Operating Voltage 220 V AC
Fixation Instruction with 2 Pcs Pole Clamp
One triple signal head and one pedestrian signal head can be connected. Operating time can be easily changed with LCD screen.



GARAGE KIT CONTROL UNIT

SN-15-043

Size 200 x 300 x 130 mm
Weight 2 kg
Operating Voltage 220 V AC
Mounting With 2 Pcs Brackets
Explanation It is especially used to prevent vehicles from colliding at garage entrances and exits and to determine transition priority

MAESTRO INTERSECTION CONTROLLER

- The Turkish Standards Institute (TSE) approval (TS EN 50556)
- Microcontroller-based modular structure
- Easy programming with the Bluetooth or USB interconnection
- Up to 32 signal groups, 32 and 32 isolated from the loop detector input
- Precision lamp current and voltage controls and secure signaling
- 4, 8, 12, 16, 20, 24, 28 and 32 group opportunities
- Ethernet, GPRS and SMS remote connection options
- 2 separate programming interface for new and experienced users
- All entries for the measurement of compliance with the census and occupancy rate
- External connections for 2 x USB port (PC, GSM, GPS, etc.).
- 16 units 16 units in different phases defined in phase and signal plan
- 48 units 16 units the signal sequence using the steps described in step
- Traffic Adaptive mode of operation for the logical function blocks
- Opening and closing sequences
- In order to avoid the unsafe or defective signalisation traffic signal plans for using the signal outputs to simulate
- The status of normal and fault modes flash, flash colors and frequencies



Product Types and Codes

- SN-06-01-100** 4 gr Maestro Intersection Controller
- SN-06-01-101** 8 gr Maestro Intersection Controller
- SN-06-01-102** 12 gr Maestro Intersection Controller
- SN-06-01-103** 16 gr Maestro Intersection Controller
- SN-06-01-104** 20 gr Maestro Intersection Controller
- SN-06-01-105** 24 gr Maestro Intersection Controller
- SN-06-01-106** 32 gr Maestro Intersection Controller

Product Types and Codes

- SN-06-01-150** SSM Module
- SN-06-01-151** CPU Module
- SN-06-01-152** MMI Module
- SN-06-01-153** PSM Module
- SN-06-01-154** BP Module
- SN-06-01-155** IO Module 8 Button



SOLAR POWERED SYSTEMS

Soltra products are manufactured according to the traffic and road safety standards.

Soltra products are used in 81 cities in Turkey and used in more than 50 countries around the world.

Solar LED Road Stud: Aluminium body, LEDs that meet EN 12368 and EN 12966 standards, NiMh battery with high charge capability, IP 67 protection class.

Solar LED Flashers: LEDs that meet EN 12368 and EN 12966 standards, IEC 61215 certificated solar panel, TSE certificated battery and %100 PC body

Solar LED Traffic Signs: High Performance reflective sign, LEDs that meet EN 12368 and EN 12966 standards, IEC 61215 certificated solar panel, TSE certificated battery, IP 65 Metal or Aluminium housing.

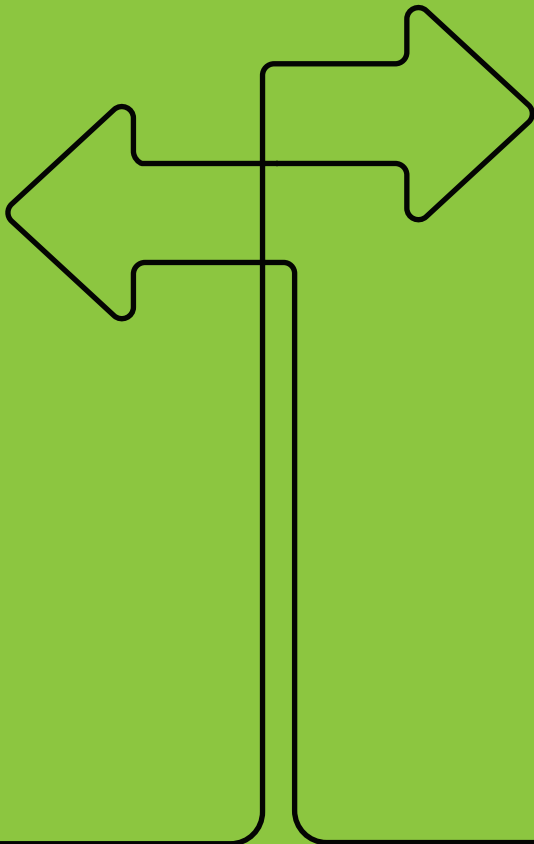

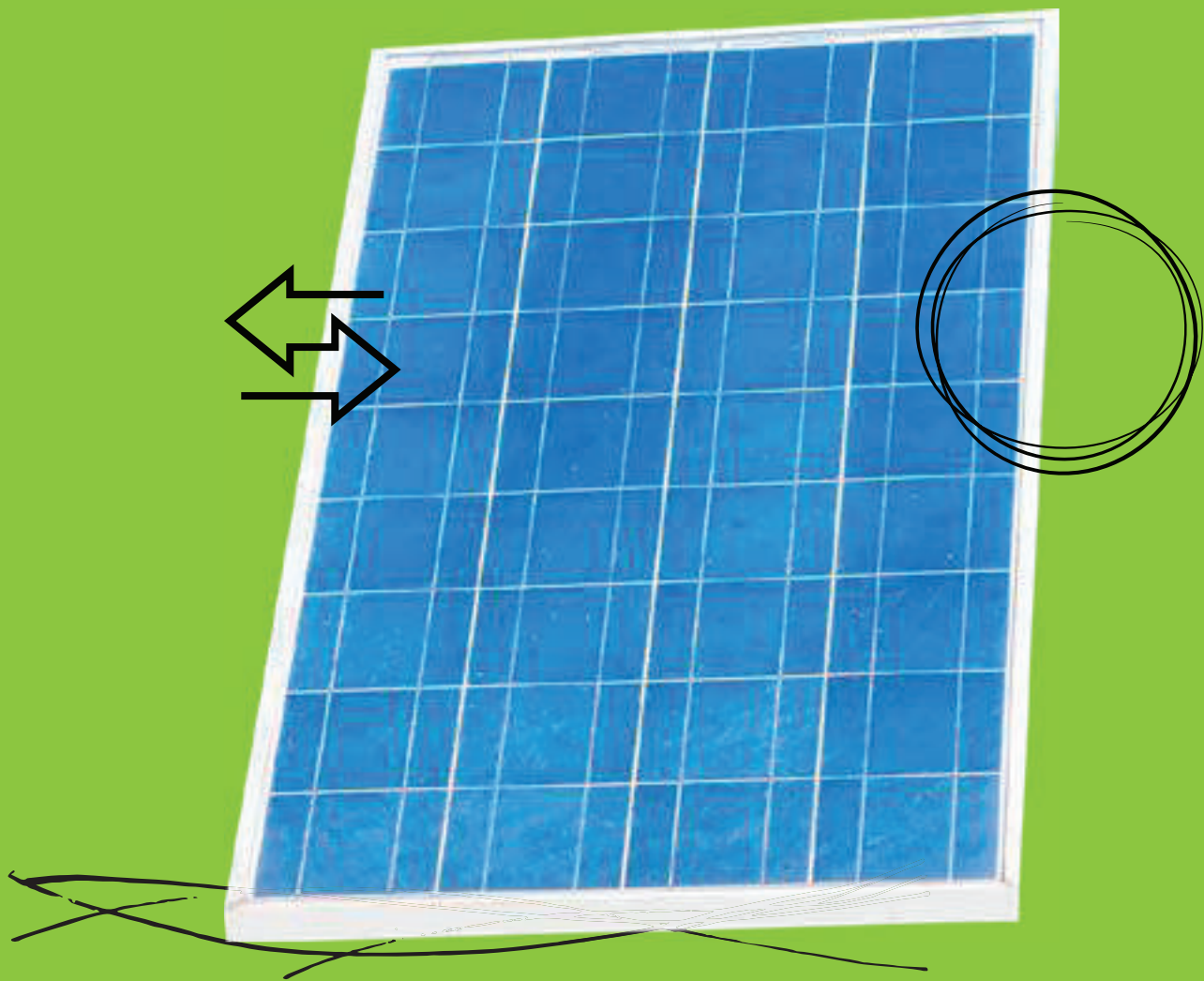



SOLAR ROAD STUD (RED) ECO

SL-01-100E

Size	125 x 145 x 28 mm
Material	Al body and TPE protective base
Weight	0.45 kg
Solar Panel	0.4 W 3 V Solar Panel
Battery	1.2 V 600 mAh
Other Details	5 mm, 3 x 3 pieces LEDs at both sides
Fixation	2 x 7,5 x 80 mm buldex screw and 12 mm plastic fixing plug



SOLAR POWER LED TRIANGLE FLASHER

SL-01-200 (YELLOW)

SL-01-201 (RED)

Size	280 x 250 x 135 mm
Weight	0.9 kg
LED	2 x 1 W Power LED, Red or Yellow
Material	PC-ABS
Other Specifications	Double-faced lens structure, 2 x 1.2 V 2000 mAh NiMh rechargeable battery, 1 x 3 V 250 mA solar panel 2 x 1 W EN 12368 traffic standard compatible power LEDs



SOLAR TRIANGLE FLASHER (ECO)

SL-01-210

Size	235 x 210 x 95 mm
Weight	0.8 kg
LED	2 x 1 W Power LED, Red, Yellow
Other Specifications	Double faced lens structure 1.2 V 1200 mAh Nimh rechargeable battery
Material	Polycarbonate / ABS
Box Size	300 x 320 x 100 mm
In Box	1 piece

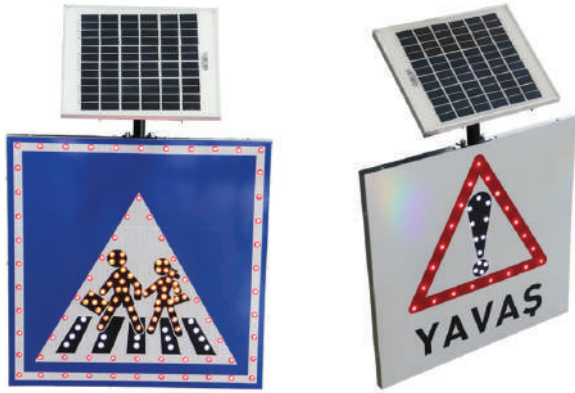

SOLAR LED SIGNS WITH NORMAL PERFORMANCE REFLECTIVE

Solar Panel
Battery
Housing Type
Reflective Material
LED

10W Polycrystal (20W Optional)
 12V 7Ah Dry Type
 Galvanized
 Normal Performance
 9 mm LED



SOLAR LED SIGNS WITH HIGH PERFORMANCE REFLECTIVE



Solar Panel
Battery
Housing Type
Reflective Material
LED

10W Polycrystal (20W Optional)
 12V 7Ah Dry Type
 Black electrostatic powder paint
 High Performance
 9 mm LED



SOLAR LED ROAD MAINTENANCE SIGNS WITH NORMAL PERFORMANCE REFLECTIVE

Solar Panel
Battery
Housing Type
Reflective Material
LED

10W Polycrystal
 12V 7Ah Dry Type
 Galvanized metal sheet
 Normal Performance
 9 mm LED



200mm SOLAR FLASHER WITH LEDs

- SL-03-01-200** Black Standard Housing
- SL-03-03-200** Black Sintra Housing

Diameter	200 mm
Color	Black, grey-black
Solar Panel	6 V, 5 W polycrystal
Accumulator	6 V, 4 Ah Dry type
LED	10 mm, Yellow, Red



300mm SOLAR FLASHER WITH LEDS

- SL-03-01-300** Black Standard Housing
- SL-03-03-300** Black Sintra Housing

Diameter	300 mm
Color	Black, grey-black
Battery	12 V, 7 - 18 Ah
Solar Panel	10-20 W
Battery	12 V, 7 - 18 Ah
LED	10 mm, Yellow, Red



300 mm SOLAR POWERED GPS SYNCHRONIZED FLASHER WITH LEDS

SL-03-01-400

Diameter	300 mm
Housing Color Options	Black, Grey-Black
Solar Panel	20 W Polycrystal
Battery	12 V, 20 Ah Deep Cycle
LED	10 mm/5 mm, Yellow, Red
Synchronization	GPS module and indoor antenna
Operating Mode	Operating in 8 different scenarios, Smart Mode, Night Mode
LED Brightness	Adjustable (Dimming)
Power Consumption	Max 4 W
Charge Type	MPPT



200mm SOLAR FLASHER WITH POWER LEDs

SL-04-01-200

Dimension	200 mm
LED	Power LED / Yellow, Red
Light Distribution	Fresnel Lens
Protection Cover	Hermetic case
Solar Panel	5 W polycrystal
Battery	6 V 4 Ah Dry type



300mm SOLAR FLASHER WITH POWER LEDs

SL-04-01-300

Diameter	300 mm
LED	10 mm LED or Power LED / Yellow, Red
Module	2 pcs flasher
Solar Panel	20 W polycrystal
Battery	2 pcs 12 V 7 Ah Dry type



300mm SOLAR DOUBLE FLASHER WITH LEDs

SL-05-01-300

Diameter	300 mm
LED	10 mm LED or Power LED / Yellow, Red
Module	2 pcs flasher
Solar Panel	20 W polycrystal
Battery	2 pcs 12 V 7 Ah Dry type

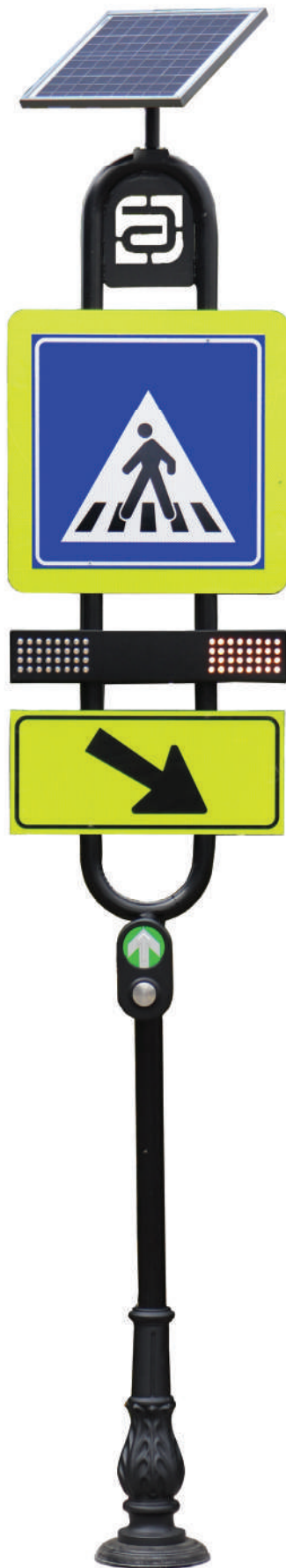

INTELLIGENT PEDESTRIAN CROSSING SYSTEM

SL-07-01-001

Solar Panel	10 W Polycrystal
Battery	12 V, 7 Ah
LED	9 mm / Yellow, Red
Reflective Material	High Performance (Type-4)
Detection	With Botton
Pole Height	3 mt
Pole Type	Metal, flanged
Fixation	With Anchorage and Decorative Base
Description	When the pre-warning system is started, the LED warning light towards the drivers will flash to warn the drivers and help pedestrians to cross safely.

SOLAR PORTABLE VEHICLE SIGNAL HEAD WITH POWER LEDS

SN-02-01-10-200



Solar Panel	2 x 20 Watt Monocrystal (2 axis movable)
Battery	12 V 65 Ah Gel Battery
Communication Frequency	RF Trans receiver 868 MHz
Communication Distance	2 Km (Open Field)
Power Consumption	18 Watt
Housing Type	Metal Sheet (Foldable)
Housing Size	400 x 500 x 3000 mm
Pole Height	2.70 m
Signal Head Type	200 mm Vehicle Signal Head with Power LEDs
Signal Head Housing Type	Polycarbonate (%100 PC)
Fixation	4 pieces of legs and 16 pcs screw and fixing plug
Hardware Content	Vehicle signal head, Solar panel group, Battery group, Regulator, Portable pole and housing set
Optional Hardware	Pedestrian signal head, Pedestrian button
Mode of Operation	4 pcs of device can operate synchronized.

ECO SOLAR LED LIGHT 10 W

LXSL-SK1-10W 10 W



Power	10 W
Light Output	1200 lm
Battery	18 Ah
Solar Panel	20 W
Operating Voltage	12 V
Charge Control	4A PWM Smart Solar Charge Controller
Pole Length	3 meters
Pole Diameter	60 mm
Operating Temperature	-30°/+50°C

SOLAR MOBILE SPEED WARNING SYSTEM WITH DOPPLER RADAR 80 x 85 CM

LD-02-03-260

Solar Panel	4 x 20 Watt (2 axis adjustable)
Battery	12V 65 Ah
Radar Housing Type	Aluminum
Housing Size	800 x 850 x 55 mm
LED	5 mm / Red, Green, White
Radar Type	Doppler Radar
Speed Measurement Distance (max)	200 m
IP Class	IP 65
Brightness Level	Automatically according to the environment
Pole Height	3 mt
Pole Type	Metal Sheet (Foldable)
Fixation	5 pieces of Legs and 20 pieces screw and fixing plug
Hardware Content	Solar panel group, battery group, regulator, radar screen, doppler radar, mobile pole, and body.



LED TRAFFIC SIGNS

Ledtra products are manufactured according to the traffic and road safety standards.

Ledtra products are used in 81 cities in Turkey and used in more than 50 countries around the world.

LED Traffic Signs (Constant and Variable Traffic Signs - VTS): Metal or aluminium housings with IP 65 protection class, LEDs that meets EN 12368 and EN 12966 standards.

LED Variable Message Signs (VMS): Metal or aluminium housings with IP 65 protection class,

LEDs that meets EN 12368 and EN 12966 standards. VMSs can be controlled at site (with PC or notebook) or remote controlled (centrals) by fiberoptics or GPRS or ADSL.

LED Speed Warning Systems (Doppler Radar Displays): Metal or aluminium housings with IP 65 protection class, LEDs that meets EN 12368 and EN 12966 standards. Customized sizes or LED colors related to Highways or Municipalities can be designed.



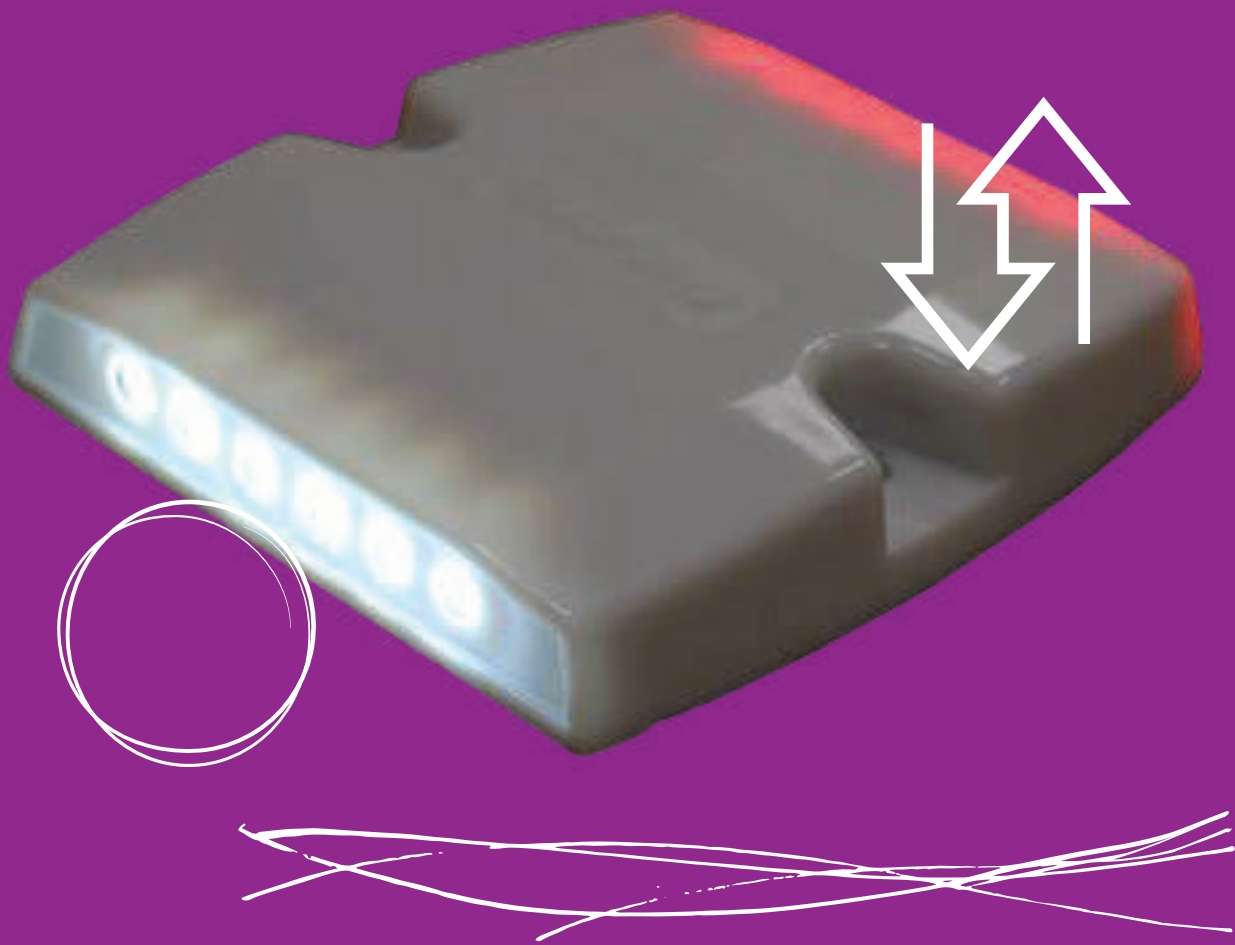

85 x 85 cm URBAN SPEED WARNING SYSTEM WITH DOPPLER RADAR

LD-02-03-200

Size	850 x 850 x 55 mm Housing
Weight	14 kg.
LED	5 mm/Red, Green, White
Radar Type	Doppler Radar
Housing Type	Aluminium
Brightness Level	Automatically (LDR)
Speed Measurement Distance (Max)	200 m
Energy	220 V AC / Solar Powered (Optional)



140 x 55 cm URBAN SPEED WARNING SYSTEM WITH DOPPLER RADAR

LD-02-03-360

Size	1400 x 550 x 55 mm
Weight	25 kg
LED	5 mm / Red, Green
Brightness Level	Automatically according to the environment
Speed Measurement Distance (Max)	200 m
Radar Type	Doppler Radar
Technical Details	In accordance with EN 12368 standard. Speed display and visual warning on graphical display with Red and Green LEDs.
Housing Type	Aluminium
Energy	220 V AC / Solar Powered (Optional)



160 x 160 cm LED RADAR (SPEED WARNING SYSTEM) LD-02-02-150

Size	1600 x 1600 x 170 mm
Weight	90 kg
LED	5 mm, amber color
Brightness Level	Automatic (LDR)
Energy	220 V AC / Solar power (optional)



240 x 200 cm SPEED WARNING SYSTEM WITH DOPPLER RADAR LD-02-01-100

Size	2400 x 2000 x 200 mm (Housing)
Weight	160 kg
LED	5mm, Yellow
Energy	220 V AC / Solar Powered (Optional)
Brightness Level	Automatically (LDR)
Speed measurement Distance	200 m

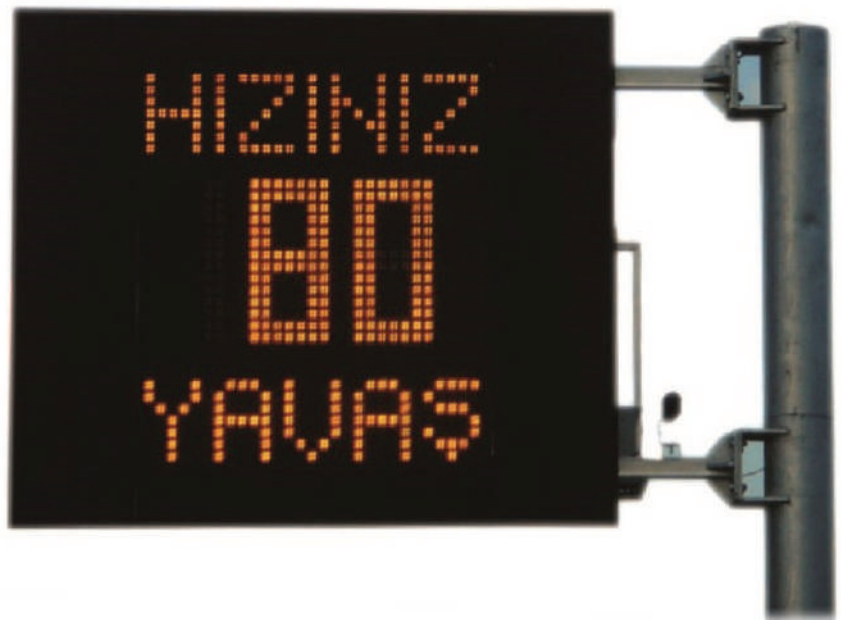

SPEED VIOLATION DETECTION SYSTEM

LD-02-04-001

System Content

Camera	2MP colored camera
Speed Detection Unit	Microwave Radar
Speed Violation Transfer Interface	USB, Wi-Fi
Speed Detection Range	Web Site
Energy	10-250 km/h
Speed Warning LED Screen Sizes	220 V AC
Weight	800x850x55 mm
LED	14 kg
Luminious	5 mm/ Red, Green, White
Energy	Automatically according to environment
	220 V AC/ Solar Powered
	Weight

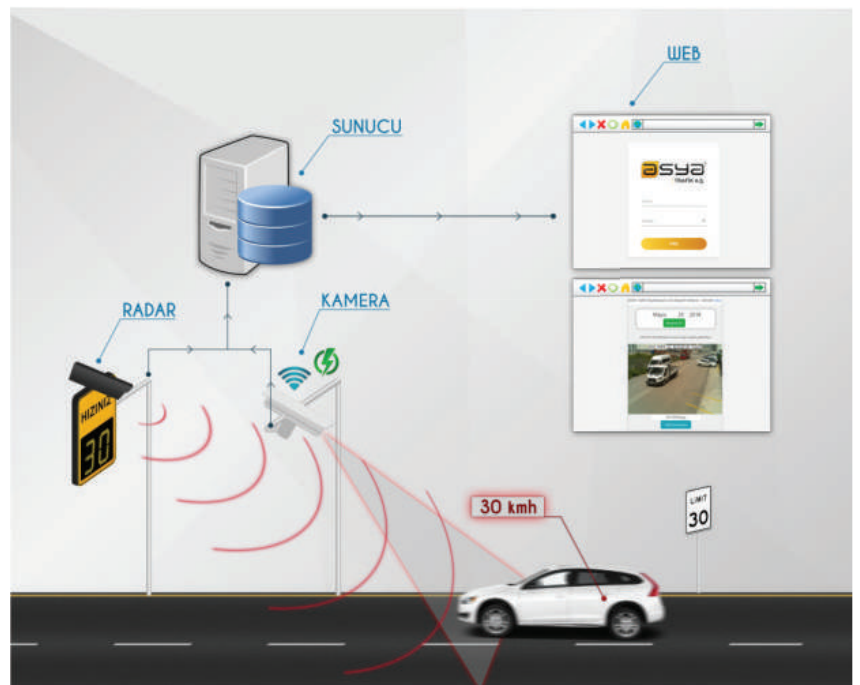



60 x 60 cm MAXIMUM SPEED LED SIGN LD-01-02-100

Ölçü Size	600 x 600 x 80 mm (housing)
Weight	22.50 kg
LED	5 mm, red, white
Energy	220 V AC
IP Class	IP 65
Brightness Level	Automatically according to environment



60 x 60 cm GAUGE-HEIGHT LED SIGN LD-01-02-150

Size	600 x 600 x 80 mm (Housing)
Weight	22.50 kg
LED	5 mm, red, white
Energy	220 V AC
Optional	RF Remote control
Brightness Level	Automatically according to the environment
IP Class	IP 65



60 x 60 cm ATTENTION-SLOW LED SIGN LD-01-02-200

Size	600 x 600 x 80 mm (housing)
Weight	22.50 kg
LED	5 mm / Red, White
Energy	220 V AC
IP Class	IP 65



100 cm MAX. SPEED LIMITATION LED SIGN

LD-01-01-100

Size	1000 x 1000 x 110 mm (Housing)
Weight	46.50 kg
LED	5 mm, red, white
Energy	220 V AC
Optional	RF Remote Controller
Speed Options	30-40-60 or 30-50-70
Brightness level	Automatically according to the environment
IP Class	IP 65

100 x 100 cm GAUGE-HEIGHT LED SIGN

LD-01-01-150



Size	1000 x 1000 mm (Housing)
Weight	46.50 kg
LED	5 mm, red, white
Energy	220 V
Optional	RF Remote Controller
Height Options	3.60 – 4.60
Brightness Level	Automatically according to the environment
IP Class	IP 65

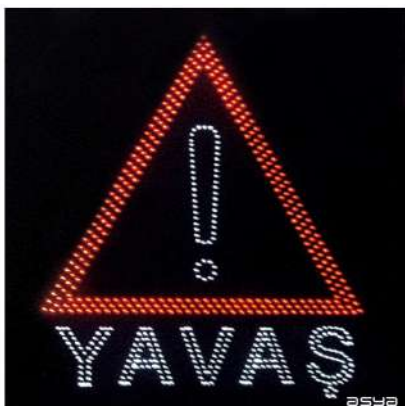

ATTENTION - SLOW LED SIGN

LD-01-01-200

Size	1000 x 1000 x 110 mm (Housing)
Weight	46.50 kg
LED	5 mm / Red, White
Energy	220 V AC
Brightness Level	Automatically according to the environment
IP Class	IP 65

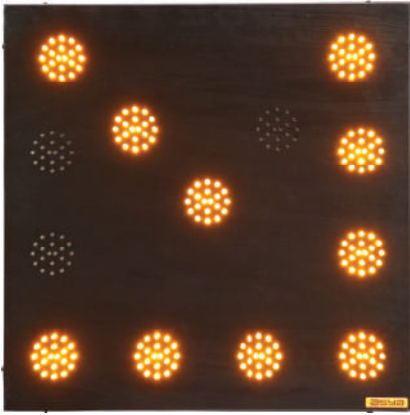

COMPULSIVE WAY (LEFT - RIGHT) LED SIGN

LD-01-03-300

Size	690 x 690 x 40 mm (Housing)
Weight	22 kg
LED	5 mm, Yellow
Energy	12-24 V
Options	Right arrow flasher, left arrow flasher
Fixation	With truck mounting equipments
IP Class	IP 65



LANE CONTROL SYSTEM (LCS)

LD-01-01-250

Size	1000 x 1000 x 110 mm (Housing)
Weight	46.50 kg
LED	5 mm, red, green
Energy	220 V AC
Optional	RF Remote controller
Brightness Level	Automatically according to the environment
IP Class	IP 65



SCHOOL - PEDESTRIAN CROSSING LED SIGN

School: LD-01-04-100

Pedestrian: LD-01-04-150



Size	650 x 650 x 80 mm (Housing)
Weight	27.80 kg
LED	5 mm, red, yellow
Energy	220 V AC
IP Class	IP 65

ELECTRICAL LED ROAD STUD (TUNNEL STUD)

LD-04-01-110

Material	PC or ASA Plastic
Size / Weight	100 x 105 x 18 mm / 275 gr
LED Type / Number of LEDs	5 mm / 2 x 6 pcs.
LED Colors	Red / White / Blue / Amber / Green
Luminous Intensity	Min 5.000 mcd
Protection Class	IP 68
Operating Voltage	DC 24 V

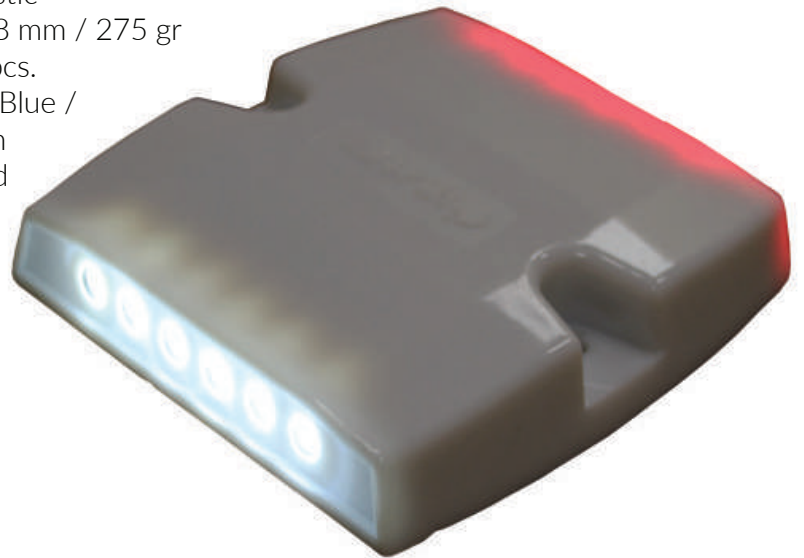

LED ROAD STUD CONTROLLER

LD-04-01-203

Size	15 x 35 x 50 cm
IP Class	IP 66
Operating Mode	Always ON – Flash – Sequential for each side
Max. Number of Buttons	50 – 100 (According to the Project)
Input Voltage	220 V AC
Output Voltage	24 V DC
Output Terminals	4
Control Modes	With LCD Screen inside the cabinet or with SCADA





COMBINED FIRE EXTINGUISHER AND SOS SIGN FOR TUNNELS

LD-05-02-100

Housing Material /Color	DKP Metal / Electrostatic Black Paint
Dimensions	710 x 300 x 125 mm
Weight	8.50 kg
LED Specs	High performance White Power LEDs
Reflective Class	High Performance Prismatic Type 4
Surface Material	3 mm Plexiglass
Operating Voltage	220 V AC / 50 Hz.
Power Supply	12 V SMPS
Cover Lock	Structure with latch
Max. Power Consumption	20 W



FIRE EXTINGUISHER SIGN FOR TUNNELS

LD-05-03-100

Housing Material / Color	DKP Metal / Electrostatic Black Paint
Dimensions	365 x 300 x 125 mm
Weight	5 kg
LED Specs	High performance White Power LEDs
Reflective Class	High Performance Prismatic Type 4
Surface Material	3 mm Plexiglass
Operating Voltage	220 V AC / 50 Hz
Power Supply	12 V SMPS
Cover Lock	Structure with latch
Max. Power Consumption	Max. Power Consumption: 15 W



LED SURFACE ILLUMINATED EMERGENCY EXIT TUNNEL SIGN

LD-05-01-100

Housing Dimensions	505 x 885 x 180 mm
Surface Size	440 x 400 mm
Weight	8 kg
Housing Material	Aluminium
LED Type	White Power LED
Max. Power Consumption	25 W
Reflective Class	High Performance Prismatic Type 4
Surface Material	3 mm Plexiglass
Operating Voltage	220 V AC / 50 Hz
Power Supply	12 V SMPS
Cover Lock	Structure with latch

EMBEDDED ALUMINIUM HARD-WIRED LED ROAD STUD

LD-04-01-900



Size	120 x 118 x 71 mm
Weight	0.8 kg
Body Material	Aluminium
LED	5 mm / Red, Green
Number of LEDs	3 pcs Red, 3 pcs Green (Total 6 pieces on every direction)
Operating Voltage	24 V DC
Fixation	Holes are opened on the road and placed in the slot and glued with adhesive

CROSSING PAVEMENT LIGHT (FOR PEDESTRIAN)

SN-15-050

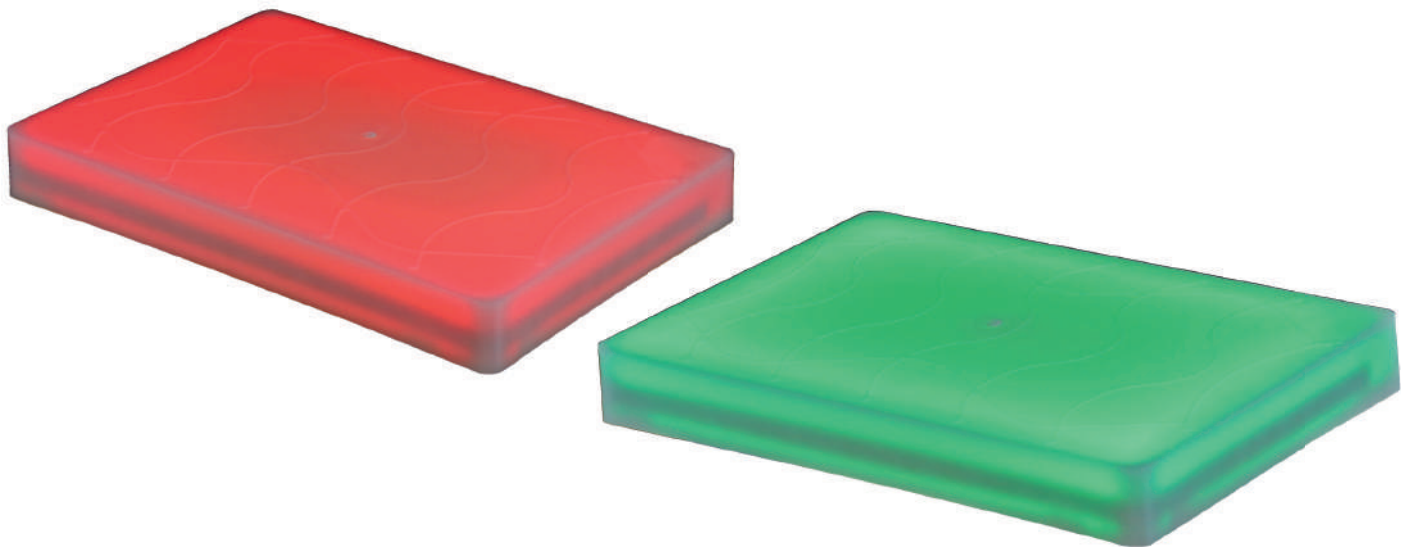

Size	300 x 200 x 35 mm
Weight	2.4 kg
Operating Voltage	24 V DC
Material (Body)	Polycarbonate
LED	Red and Green LED Strip
Protection	Resin-casting
Mounting	Holes are opened on the pavement and placed in it and glued with its adhesive



PLASTIC, RUBBER, METAL ROAD SAFETY PRODUCTS

Plastra products are manufactured according to the traffic and road safety standards.

Plastra products are used in 81 cities in Turkey and used in more than 50 countries around the world.

Rubber Speed Bumps: 1st class rubber material, long life high performance yellow reflective tapes.

Traffic Cones: PVC material, normal or high performance reflectives.

Aluminium Road Studs: Resistant to heavy road traffic pure aluminium body.

Delineators: %100 TPU material, flexible, normal or high performance reflectives.

Warning Posts: PPC material, rubber or plastic bases, normal or high performance reflectives

Parking Products: Corner protectors, traffic mirrors, car stoppers etc.



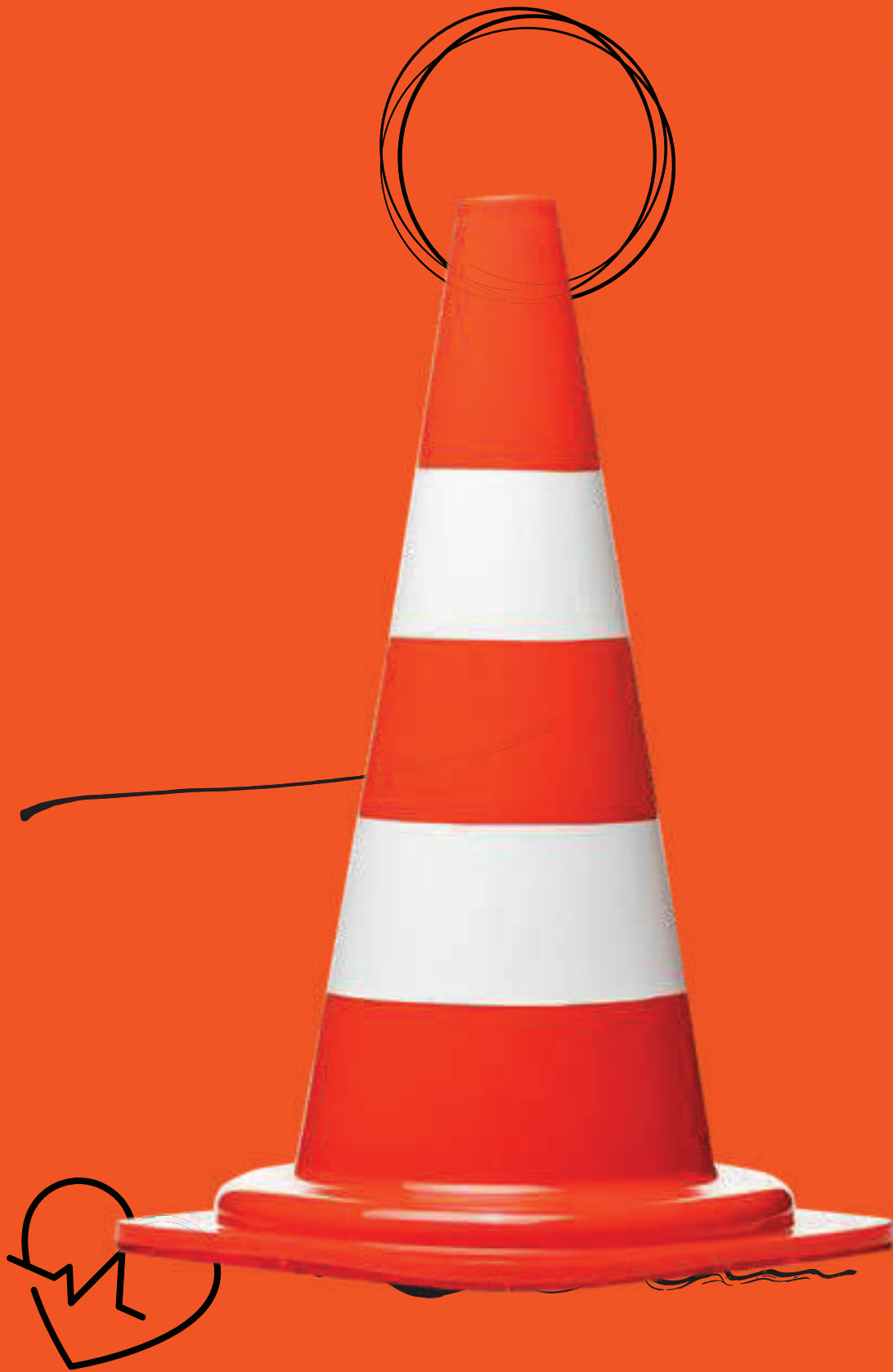

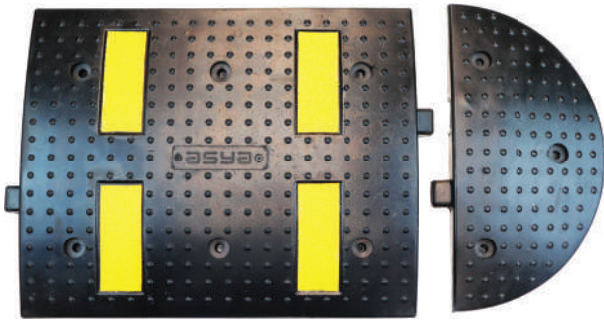

RUBBER SPEED BUMP 50 x 40 x 4.5 cm

PL-01-100

Body Size	500 x 400 x 45 mm
Header Size	400 x 200 x 45 mm
Material	Rubber
Color Options	Black
Weight Body	7 kg
Header	2 kg
Tech. Details	4x reflective yellow road tape
Fixation	10 x 120 mm Trifon screw, 16 mm plastic fixing plug

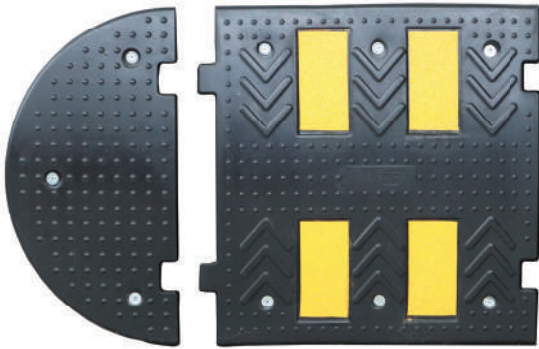

RUBBER SPEED BUMP 50 x 50 x 4.5 cm

PL-01-200

Body Size	500 x 465 x 45 mm
Header Size	500 x 250 x 45 mm
Material	Rubber
Color Options	Black
Weight Body	9 kg / Header: 2.80 kg
Tech. Details	4 x reflective yellow road tape
Fixation	10 x 120 mm Trifon screw, 16 mm Plastic fixing plug



RUBBER SPEED BUMP 50 x 60 x 4.5 cm

PL-01-300

Body Size	600 x 470 x 45 mm
Header Size	600 x 300 x 45 mm
Material	Rubber
Color Options	Black
Weight Body	10.50 kg
Header	4 kg
Tech. Details	4/6 x reflective yellow road tape
Fixation	10 x 120 mm Trifon screw, 16 mm Plastic fixing plug

RUBBER SPEED BUMP (ECO) 50 x 40 cm

PL-01-110



Body Size	500 x 400 x 45 mm
Header Size	400 x 200 x 45 mm
Material Type	Rubber
Color Options	Black
Weight: Body	5.50 kg / Header 2.55 kg
Technical Details	2x yellow rubber tape
Fixation	10 x 100 mm Trifon screw, 16 mm plastic fixing plug

RUBBER SPEED BUMP (ECO) 50 x 50 cm

PL-01-210



Body Size	500 x 500 x 40 mm
Header Size	500 x 250 x 40 mm
Material Type	Rubber
Color Options	Black
Weight Body	6.75 kg / Header 2.35 kg
Technical Details	4x yellow rubber tape
Fixation	10 x 100 mm Trifon screw, 16 mm plastic fixing plug

RUBBER SPEED BUMP (ECO) 50 x 60 cm

PL-01-310

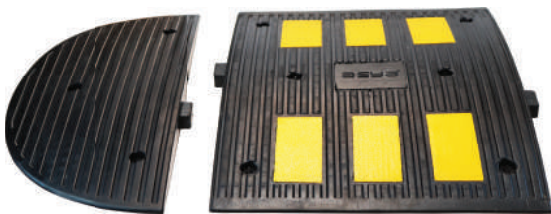

Body Size	500 x 600 x 45 mm
Header Size	600 x 300 x 45 mm
Body Weight	8.25 Kg
Header Weight	3.00 Kg
Material	Rubber
Color Options	Black
Tech. Details	6x Reflective Yellow Road Tape
Fixation	10 x 100 mm Trifon screw and 16 mm Plastic fixing plug



RUBBER SPEED BUMP 90 x 50 cm

PL-01-800

PL-01-801

Body Size	500 x 900 mm
Header Size	500 x 250 mm
Material Type	Rubber
Color Options	Black
Technical details	8x yellow rubber tape
Fixation	10 x 120 mm trifon screw, 16 mm plastic fixing plug



TYRE KILLER

PE 50 12290 UB

PE 50 12291 UB K

Header Size	500 x 500 x 60 mm
Body	90 x 500 x 60 mm
Weight	7,3 kg
Material	Metal / PPC
Fixation	6 pcs trifon screw and plastic fixing plug

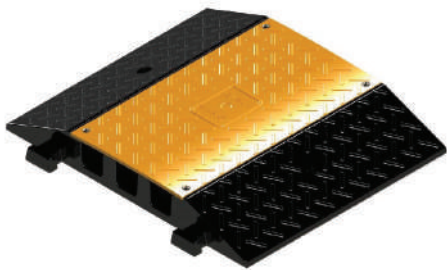

CABLE DUCT SPEED BUMP

PE-50-12298 UB

PE-50-12299 UB

Body Size	500 x 600 x 75 mm
Corner Size	500 x 600 x 75 mm
Weight	8.7 kg / Corner3 kg
Material	PPC
Fixation	2 pcs 10 x 100 mm trifon screw, 16 mm plastic fixing plug
Other Features	5 cm, There are 3 cable ducts





CARPARK CORNER GUARD

PL-07-300

Dimensions	90 x 115 x 810 mm
Weight	1.4 kg
Material type	PVC
Color Options	Black, optional any colour
Technical details	High performance reflective sheet
Installation	6 pcs 4 x 50 mm screws, pegs, washers



RUBBER CAR PARK CORNER GUARD (ECO-CORNERED)

PL-07-310

Size	800 x 100 x 100 mm
Weight	1.6 kg
Technical Details	4 Pcs High Reflective Sheet
Material	Rubber
Fixation	6 Pcs buldex screw and nail



OVAL RUBBER CAR PARK CORNER GUARD (ECO)

PL-07-320

Size	800 x 100 x 100 mm
Weight	2.75 Kg
Technical Details	4 Pcs High Reflective Sheet
Material	Rubber
Fixation	6 Pcs buldex screw and nail



DELINEATOR 30 x 8 cm (ECO) PL-03-100

Dimension	300 x 80 mm
Base Diameter	200 mm
Weight	0.67 kg (±%5)
Material	TPU
Color	Orange, other colors are optional
Reflective	Metallized
Technical Details	Flexible, unbreakable
Fixation	10 x 100 mm trifon screw and 16 mm plastic fixing plug



DELINEATOR 45 x 8 cm (ECO) PL-03-200

Size	450 x 80 mm
Base Diameter	200 mm
Weight	0.90 kg
Reflective	Metalized
Material	TPU
Color	Orange, other colors are optional
Technical Details	Flexible, unbreakable
Fixation	10 x 100 mm Trifon screw, 16 mm Plastic Fixing Plug



DELINEATOR 75 x 8 cm PL-03-400

Size	750 x 80 mm
Base Diameter	1.20 kg
Material	TPU
Reflective Material	High Performance, Class 3 (circular and rectangular) Reflective Sheet
Color Options	Orange, other colors are optional
Fixation	10 x 100 mm Trifon screw, 16 mm Plastic Fixing Plug



DELINEATOR 75 x 8 cm (ECO) PM-70-2076

Dimension	750 x 80 mm
Base Diameter	210 mm
Weight	0.90 kg (±%5)
Material	Compound
Color	Orange
Reflective	3 pieces Metallized Reflective
Technical Details	Flexible, unbreakable
Fixation	10 x 100 mm trifon screw and 16 mm plastic fixing plug

DELINEATOR 100 x 8 cm (ECO) PL-03-850



Size	1000 x 80 mm
Base Diameter	200 mm
Weight	1.50 kg
Reflective	Metalized
Material	TPU
Color	Orange, other colors are optional
Technical Details	Flexible, unbreakable
Fixation	10 x 100 mm Trifon screw, 16 mm Plastic Fixing Plug

FLEXIBLE DELINEATOR SIGNBOARD PL-03-700



Size	550 x 215 mm
Base Diameter	1.15 kg
Material	TPU
Reflective Material	High Performance, Class 3 (circular and rectangular) Reflective Sheet
Color Options	Black, optional other colors
Fixation	On 300 x 80 mm, 450 x 80 mm or 750 x 80 mm Traffic Delineator by screwing



PLASTIC ROUND TRAFFIC POST WITH PLASTIC BASE (ECO)

PL-06-201

Size	120 x 1200 mm
Weight	9.50 Kg
Material Type	PP+PE
Reflective Quantity	3 pieces
Base Diameter	400 mm
Base Details	Plastic Base
Technical Specifications	Warning signs, flashers, etc. can be attached using the upper grooved section.



PLASTIC ROUND TRAFFIC POST WITH PLASTIC BASE (ECO)

PM-70-4125

Size	70 x 1000 mm
Weight	4.30 kg
Material	PP+PE
Reflective Tape	4 pieces
Base Diameter	350 mm
Base Details	Plastic Base



PLASTIC ROUND TRAFFIC POST WITH PLASTIC BASE (ECO)

PL-06-202

Size	70 x 1000 mm
Weight	4.30 kg
Material	PP+PE
Reflective Tape	4 pieces
Base Diameter	350 mm
Base Details	Plastic Base



PLASTIC ROUND TRAFFIC POST WITH PLASTIC BASE

PL-06-200

Size	110 x 1200 mm
Material	PPC (post) and PP (base)
Weight	8.3 kg (1.4 kg / 6.9 kg)
Fixation	Portable or optional with screw and nails
Color Options	Orange, Red and optional
Reflective Material	3 pieces, optional up to 6 pieces



PLASTIC ROUND TRAFFIC POST WITH RUBBER BASE

PL-06-100

Size	110 x 1200 mm
Material	PPC ve Rubber
Weight	8.3 kg (1.4 kg / 6.9 kg)
Mounting Shape	Portable or optional screw-dubel
Color Options	Orange, Red, other optional colors
Reflective Material	3, optional up to 6



WARNING BARRIER WITH POSTS

PL-06-300

Size	1800 x 1200 mm
Weight	19 kg (Plastic base) / 21 kg (Rubber base)
Reflective	Normal Performance
Color Options	Red, Orange, Optional
Technical Details	Portable, 2 pcs post and 1 pcs reflective sign



PVC TRAFFIC CONE 50 cm DOUBLE REFLECTIVE 6 CORNERS

PL-02-156

Height	500 mm
Base Size	330 mm
Weight	1200 g
Product Type	PVC
Base Specification	6 Corners
Color Options	Orange
Technical Specifications	With Hook, Double Reflective Type

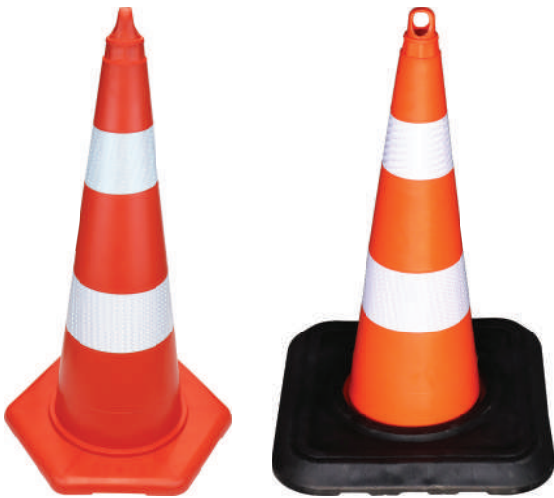

PVC TRAFFIC CONE 75 cm WITH BASE (ECO)

PL-02-356

PL-02-355 (With Base)

Height	750 mm
Base Size	490 mm
Weight	5400 gr
Material Type	PVC
Base Specification	4 edges
Color Options	Orange
Other Details	Handling hook, 2 pieces reflective material.

PVC TRAFFIC CONE (ECO) 90 cm DOUBLE REFLECTIVE

PL-02-401



Height	900 mm
Weight	3.3 kg
Base Type	4 edges
Base Edge Size	380 x 380 mm
Material	PVC
Color Options	Orange
Technical Detail	Handling hook



ULTRA CAT EYES CONE PE-50-12351TKA

Size	600 mm
Base Size	370 mm (4 Edge)
Material	PPC
Color Options	Red, Yellow, Blue, Green
Technical Detail	Accessorize Applicable
Product Types and Codes	PE-50-12351 600 mm / 1.35 kg



6 EDGES TRAFFIC CONE (ECO) PE-50-12302TK

Size	500 mm
Base Size	350 mm (6 Edge)
Material	PPC
Color Options	Red
Technical Detail	With handling hook



PEDESTRIAN CHANNELIZERS PE-50-12205

Size	500 mm
Base Size	250 mm
Material	PE
Color Options	Anthracite, Blue
Weight	1.50 kg



RUBBER PARKING CAR STOPPER

PL-07-100

Size	740 x 150 x 100 mm
Material	Rubber
Weight	6.50 kg
Color Options	Black
Reflector	4xReflective Yellow Road Tape
Fixation	10 x 150 mm Trifon screw, 16 mm Plastic screw

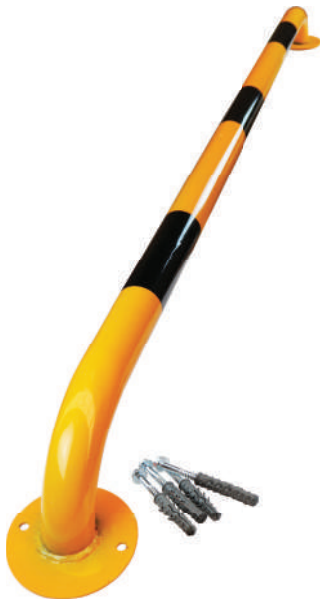

PARKING CAR STOPPER (PIPE TYPE)

PL-07-150

Length	1800 mm
Height	120 mm
Flange	Diameter 180 mm / Thickness 2.5 mm
Pipe	Diameter 60 mm / Thickness 2 mm
Paint	Black, Electrostatic paint with yellow reflective sheets
Installation	10 x 120 mm screw and 16 mm plastic plug

PARKING CAR STOPPER 180 cm

PL-07-110



Size	1830 x 150 x 100 mm
Weight	17.5 Kg (2 Pcs)
Technical Details	8 Pcs Reflective Tape with Glass Beads
Reflective	Yellow/White
Material	Rubber
Fixation	6 Pcs (10 x 150 mm Trifon Screw, 16 mm Plastic Screw)

RUBBER ROAD SEPERATOR

PL-01-500



Height	600 mm
Weight	3.1 kg
Material type	2 mm iron
Color Options	Yellow, Red, Black
Paint	Electrostatic paint
Technical Details	Locked, with key, with reflective
Installation	10 X 100 mm trifon screw and 16 mm plastic plug

RUBBER CAR STOPPER (WITH RUBBER MECHANISM POLE)

PL-01-562



Stopper Size	1800 x 200 x 150 mm
Pole Size	920 x 60 mm
Pole Reflective	3 pcs, high performance reflector
Road Stud Size	100 x 100 mm
Road Stud Reflective	2 pcs Prismatic Reflective
Weight	44 Kg
Material	Rubber Stopper, Plastic Pole
Fixation	3 pcs (10 x 150 mm Trifon Screw, Bolt 16)

PLASTIC ROAD SEPERATOR WITH 75 CM DELINEATOR

PL-05-400



Size	1000 x 200 x 80 mm
Total Weight	3.9 kg
Delineator Weight	0.9 kg
Base Weight	3 kg
Material	PPC Base - TPU Delineator
Delineator Size	750 x 80 mm
Reflective	3 pcs Metallized Reflective Band
Delineator Color	Orange
Base Color	Yellow
Fixation	4 pcs 10 x 120 mm Trifon screw and plastic plug

ALUMINIUM ROAD STUD WITH DOUBLE RODS

PL-04-400

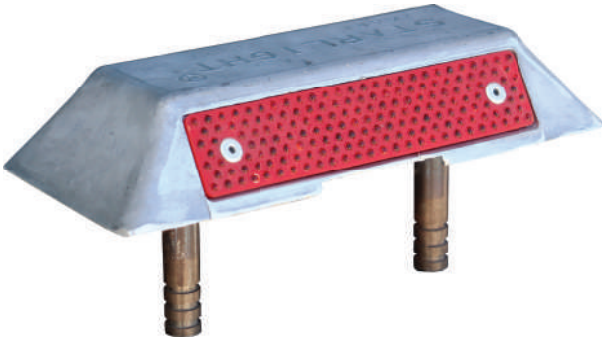

Size	220 x 100 x 40 mm
Material	Al
Weight	0.94 kg
Reflector	2 x 171 pcs glass beads
Compression Resistance	35 tons
Fixation	14 x 65 mm 2 rods

ALUMINIUM ROAD STUD WITH ROD

PL-04-200



Size	100 x 100 x 20 mm
Material	Al
Weight	0.32 kg
Reflector	2 x 43 pcs glass beads
Compression Resistance	25 tons
Fixation	25 x 50 mm rod

ALUMINIUM ROAD STUD WITH ROD (GLASS BEADS)

PE-50-12011-YB



Body	21 x 100 x 100 mm
Weight	0.40 kg
Material	Al
Fixation	2 x 5 cm anchorage with epoxy cement
Reflector	3 + 3 Cat eye

PLASTIC OVAL ROAD STUD WITH GLASS BEADS

PL-05-600



Size	220 x 120 x 28 mm
Material	PPC
Weight	0.23 kg
Color Options	Yellow, other colors are optional
Reflective	6 x 7 pcs Glass Beads (Red or White)
Compression Resistance	35 tons
Fixation	with 4 pcs 7.5 x 80 mm buldex screw and nail

PLASTIC MINI ROAD STUD WITH GLASS BEADS

PL-05-500



Size	128 x 88 x 30 mm
Material	PPC
Weight	0.135 kg
Color options	Yellow, other colors are optional
Reflector	4 x 7 pcs glass bead (Red or White)
Compression Resistance	35 tons
Fixation	with 4 pcs 7.5 x 80 mm buldex screw and nail

METAL ROAD STUD

PL-04-100



Size	120 x 120 x 28 mm
Material	Al
Weight	0.4 kg
Color Options	Grey
Lens	2x2 pcs 10 mm Red / White
Fixation	Screw and Plug
Compression Resistance	35 tons



ADJUSTABLE METAL PARKING POLE

PL-07-500

Product code	PL-07-500
Height	600 mm
Weight	3.1 kg
Material type	2 mm iron
Color Options	Yellow, Red, Black
Paint	Electrostatic paint
Technical Details	Locked, with key, with reflective
Installation	10 X 100 mm trifon screw and 16 mm plastic plug



METAL DELINEATOR 45 x 8.9 cm

PL-07-600

Size	450 x 89 mm
Base Diameter	170 mm
Weight	3 kg
Paint	Electrostatic paint
Color	Black
Reflective	1 pcs Metalized Reflective Tape
Fixation	10 x 100 mm Trifon screw and 16 mm Plastic plug



TRAFFIC SAFETY MIRROR

PL-07-350

Material	ABS
Color Options	Yellow-Black, White-Red
Technical Details	Acrylic Mirror
Fixation	8 Special apparatus between 50 and 75 fixed to pole Fixation to wall with screw and nail



COMPOSITE BOLLARD 47 cm

PL-02-408

Height	470 mm
Base Size	250 mm x 250 mm
Weight	10.50 Kg
Material Type	Composite
Color Options	Black
Reflective	20 mm Normal Performance Yellow Reflective
Fixation	10 x 120 mm Trifon screw and 16 mm plastic fixing plug



COMPOSITE BOLLARD 65 cm

PL-02-407

Height	650 mm
Base Size	250 mm x 250 mm
Weight	11.50 Kg
Material Type	Composite
Color Options	Black
Reflective	20 mm Normal Performance Yellow Reflective
Fixation	10 x 120 mm Trifon screw and 16 mm plastic fixing plug



TRAFFIC POST WITH RUBBER MECHANISM

PL-06-210

Dimension	107 x 6 cm
Base Edge Dimension	11 cm (Hexagon Base)
Weight	1.20 Kg
Flexibility	Patented Rubber Mechanism
Material	%100 PP
Color	Orange
Reflective	3 pcs 6 cm wide Prismatic (Type 4)
Installation Materials	4 pcs 10 x 120 Trifon Screw, 16 mm Peg

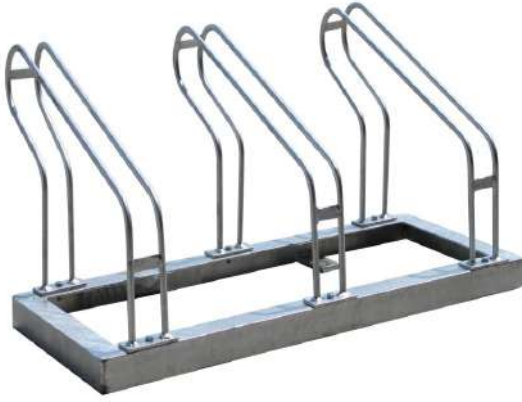

BICYCLE PARKING PLACES (3 PARKING)

PL-07-200

Dimensions	40 x 120 x 43 cm
Weight	16 kg
Material	40 x 40 brackets and 12 mm steel transmission
Protection	Hot-dip galvanized



BICYCLE PARKING PLACES (5 PARKING)

PL-07-250

Dimensions	40 x 180 x 43 cm
Weight	25 kg
Material	40 x 40 brackets and 12 mm steel transmission
Protection	Hot-dip galvanized

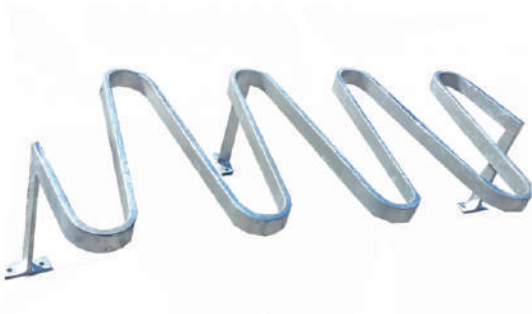

BICYCLE PARKING PLACES "Z TYPE" **PL-07-252**

Dimensions	145 x 65 x 36,50 cm
Weight	37 kg
Material	5 cm Folded Galvanized Metal
Protection	Hot-dip galvanized
Parking Qty	8 parking places
Fixation	6 pcs steel screw



PE 50 120 A PLASTIC ROUND TRAFFIC SIGN
PE 50 111 PLASTIC TRIANGLE TRAFFIC SIGN
PE 50 110 A PLASTIC RECTANGULAR TRAFFIC SIGN



PE 50 196 A ULTRA PLASTIC ROUND TRAFFIC SIGN

Material	PPC	
Measures	Plastic Round Traffic Sign	Q28 cm
	Plastic Triangle Traffic Sign	H39 cm
	Plastic Rectangular Traffic Sign	35x41 cm
	Ultra Plastic Round Traffic Sign	Q38 cm



DELINEATOR CONNECTION APPARATUS
PE 50 194 A

Material	PPC
Measures	8 cm



CONE CONNECTION APPARATUS
PE 50 126 A

Material	PPC
Measures	10.5 cm



PLASTIC CHAIN
PE 50 128 A

Material	PPC
Measures	25 m



PLASTIC CHAIN CONNECTOR
PE 50 174 A

Material	PPC
Measures	4 cm

REFLECTIVE TRAFFIC SIGNS

Reflectra products are manufactured according to the traffic and road safety standards.

Reflectra products are used in 81 cities in Turkey and used in more than 50 countries around the world.

Reflective Traffic Signs: 2 mm galvanized iron (GI), Normal Performance (Type 1) or High Performance (Type 4) reflectives, Turkish Highway standards, suitable for omega poles.

Omega Poles: Customized length and thickness, galvanized steel, corrosion resistant, suitable for traffic signs.

Customized Traffic Signs: Different sizes (60 cm, 75 cm, 90 cm, etc.), folded or plain, with rail or without rail, lambri type or not, aluminium or galvanized iron.

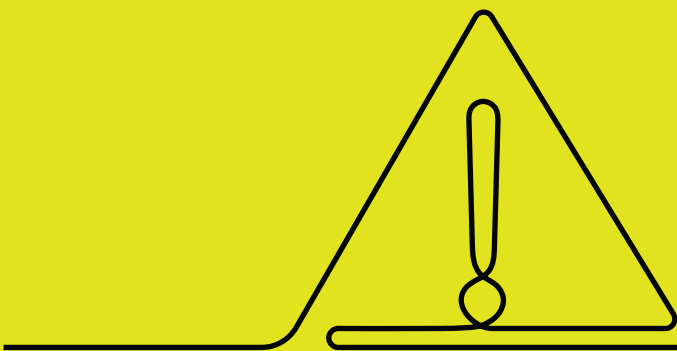

REFLECTIVE TRAFFIC SIGNS

Reflectra products are manufactured according to the traffic and road safety standards.

Reflectra products are used in 81 cities in Turkey and used in more than 50 countries around the world.

Reflective Traffic Signs: 2 mm galvanized iron (GI), Normal Performance (Type 1) or High Performance (Type 4) reflectives, Turkish Highway standards, suitable for omega poles.

Omega Poles: Customized length and thickness, galvanized steel, corrosion resistant, suitable for traffic signs.

Customized Traffic Signs: Different sizes (60 cm, 75 cm, 90 cm, etc.), folded or plain, with rail or without rail, lambri type or not, aluminium or galvanized iron.

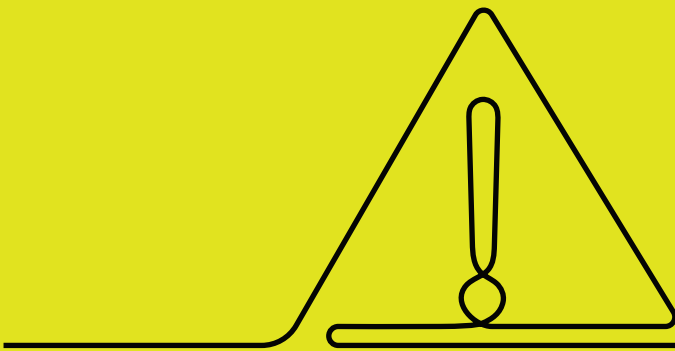

NORMAL PERFORMANCE TRAFFIC SIGNS



NORMAL PERFORMANCE REFLECTIVE MATERIAL STRUCTURE

Sizes	Standard
Sign Board	2 mm Galvanised Metal Sheet
Reflective	(Type I) Engineering Grade
Fixation	Applicable to Omega Pole

Product Type and Codes

RF-01-01-0060	Circle Traffic Sign Board (60 cm)
RF-01-01-6060	Square Traffic Sign Board (60 × 60 cm)
RF-01-01-0U90	Triangle Traffic Sign Board (90 cm)
RF-01-01-0U75	Triangle Traffic Sign Board (75 cm)
RF-01-01-5075	Rectangle Traffic Sign Board (50 × 75 cm)
RF-01-01-0S60	Octangle Traffic Sign Board (60 cm)
RF-01-01-0S75	Octangle Traffic Sign Board (75 cm)
RF-01-01-30100	Rectangle Traffic Sign Board (30 × 100 cm)

HIGH PERFORMANCE TRAFFIC SIGNS



HIGH PERFORMANCE REFLECTIVE MATERIAL STRUCTURE

Sizes	Standard
Sign Board	2mm Galvanised Metal Sheet
Reflective	High-Intensity Grade (Type 4)
Fixation	Applicable to Omega Pole

Product Type and Code

RF-02-01-0060	Circle Traffic Sign Board (60 cm)
RF-02-01-6060	Square Traffic Sign Board (60 × 60 cm)
RF-02-01-0U90	Triangle Traffic Sign Board (90 cm)
RF-02-01-0U75	Triangle Traffic Sign Board (75 cm)
RF-02-01-5075	Rectangle Traffic Sign Board (50 × 75 cm)
RF-02-01-0S60	Octangle Traffic Sign Board (60 cm)
RF-02-01-0S75	Octangle Traffic Sign Board (75 cm)
RF-02-01-30100	Rectangle Traffic Sign Board (30 × 100 cm)



Q 60 cm PLASTIC ROUND TRAFFIC SIGN RF-20-021

Dimension	600 x 600 x 20 mm
Weight	1.75 Kg
Material	%100 PC (Polycarbonate)
Production Method	Plastic Injection
Color	Black (Resistant to UV rays)
Installation	Adaptable to omega poles or pipe type traffic poles
Traffic Sign Type	Folded and with rail



60 x 60 cm PLASTIC SQUARE TRAFFIC SIGN RF-20-011

Dimension	600 x 600 x 20 mm
Weight	2.15 Kg
Material	%100 PC (Polycarbonate)
Production Method	Plastic Injection
Color	Black (Resistant to UV rays)
Installation	Adaptable to omega poles or pipe type traffic poles
Traffic Sign Type	Folded and with rail



90 x 90 x 90 cm PLASTIC TRIANGLE TRAFFIC SIGN RF-20-011

Dimension	900 x 900 x 900 x 20 mm
Weight	2.15 Kg
Material	%100 PC (Polycarbonate)
Production Method	Plastic Injection
Color	Black (Resistant to UV rays)
Installation	Adaptable to omega poles or pipe type traffic poles
Traffic Sign Type	Folded and with rail

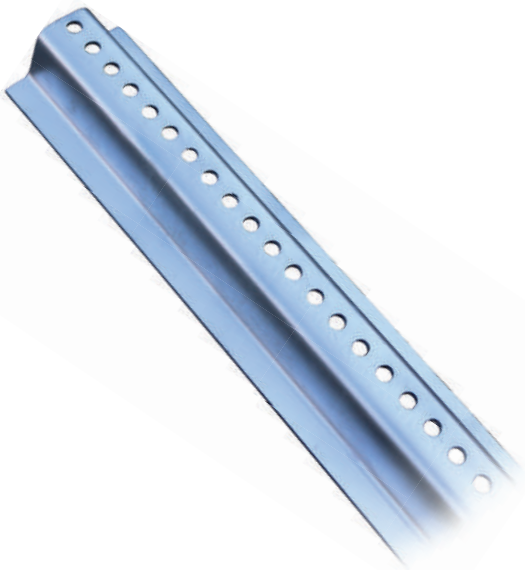

OMEGA POLES

Material	Galvanised Omega Profile
Hole Diameter	10 mm (+/- % 10)
Hole Interspace	20 mm (+/- % 10)
RF-01-100	2,5 mt length – 3 mm diameter
RF-01-200	3 mt length – 3 mm diameter
RF-01-300	3 mt length – 4 mm diameter



CUSTOMIZED SIGNS

- Any size
- Folded or unfolded
- Aluminium or galvanized bended or unbended sheet
- Panelled or plain type
- With railed or without

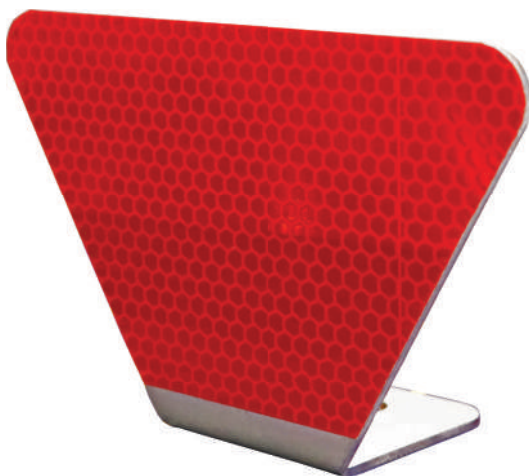

RAILGUARD REFLECTOR

RF-70-001

Size	140 x 95 x 50 mm
Mounting Place Size	50 x 50 mm
Sign Board	2 mm Galvanised Metal Sheet
Reflective	Prismatic Type-4 / White – Red Reflective
Weight	160 g

DOUBLE BENDED / FOLDED TRAFFIC SIGNS

Sizes	Standard
Signs	1,5 mm Bended and Railed Galvanized Sheet
Reflective Sheet	High Performance / Normal Performance
Fixation	Double Fixation Rails and suitable with clamps to the pipe type poles

Product Types and Codes

Normal Performance

RF-01-01-5075CB	Rectangle Traffic Sign (50 x 75 cm)
RF-01-01-6060CB	Square Traffic Sign (60 x 60 cm)
RF-01-01-0060CB	Circle Traffic Sign (60 cm)
RF-01-01-0S75CB	Octagonal Traffic Sign (75 cm)
RF-01-01-0U75CB	Triangle Traffic Sign (75 cm)

High Performance

RF-02-01-5075CB	Rectangle Traffic Sign (50 x 75 cm)
RF-02-01-6060CB	Square Traffic Sign (60 x 60 cm)
RF-02-01-0060CB	Circle Traffic Sign (60 cm)
RF-02-01-0S75CB	Octagonal Traffic Sign (75 cm)
RF-02-01-0U75CB	Triangle Traffic Sign (75 cm)



SINGLE BENDED / FOLDED TRAFFIC SIGNS

Sizes	Standard
Signs	1,5 mm Bended and Railed Galvanized Sheet
Reflective Sheet	High Performance / Normal Performance
Fixation	Double Fixation Rails and suitable with clamps to the pipe type poles

Product Types and Codes

Normal Performance

RF-01-02-5075TB	Rectangle Traffic Sign (50 x 75 cm)
RF-01-02-6060TB	Square Traffic Sign (60 x 60 cm)
RF-01-02-0060TB	Circle Traffic Sign (60 cm)
RF-01-02-0S75TB	Octagonal Traffic Sign (75 cm)
RF-01-02-0U75TB	Triangle Traffic Sign (75 cm)

High Performance

RF-02-02-5075TB	Rectangle Traffic Sign (50 x 75 cm)
RF-02-02-6060TB	Square Traffic Sign (60 x 60 cm)
RF-02-02-0060TB	Circle Traffic Sign (60 cm)
RF-02-02-0S75TB	Octagonal Traffic Sign (75 cm)
RF-02-02-0U75TB	Triangle Traffic Sign (75 cm)



from ASYA to all over the world

 +90 312 244 ASYA
2792

TURKEY

Adres : Susuz Mah. Dempa Cad. No: 25-27
Susuz, Yenimahalle, Ankara/TURKEY

Tel : +90 312 396 00 62-63

Faks : +90 312 396 00 08

e-mail : asya@asyatraffic.com